

2019 **2.0**
3.0

outdoor



DECO | VITA

OUTDOOR SERİLER 20 mm & 30 mm	
AITOS ANTRACITA	8 - 11
AITOS GREY	12 - 15
ATERRA ANTRACITA	16 - 19
ATERRA GREY	20 - 23
AUMA OAK	168 - 169
AUMA TAUPE	170 - 171
BELGIUM STONE ANTRACITA	24 - 27
BELGIUM STONE GREY	28 - 31
BLUESTONE ANTRACITA	32 - 35
BLUESTONE GREY	36 - 39
CALIZA ANTRACITA	40 - 43
CALIZA GREY	44 - 47
CLAY ANTRACITA	48 - 51
CLAY GREY	52 - 55
CLAY SAND	56 - 59
CLAY WHITE	60 - 63
CONCRETO ANTRACITA	64 - 67
CONCRETO GREY	68 - 71
CROSSOVER ANTRACITA	72 - 75
CROSSOVER BLANCO	76 - 79
CROSSOVER GREY	80 - 83
EARTH ANTRACITA	84 - 87
EARTH GREY	88 - 91
EARTH WARM GREY	92 - 95
EARTH WHITE	96 - 99
EPIRO ANTRACITA	100 - 103
EPIRO GREY	104 - 107
GRAVEL ANTRACITA	108 - 111
GRAVEL GREY	112 - 115
MAJA IVORY	116 - 119
MERCURY ANTRACITA	120 - 123
MERCURY GREY	124 - 125
MOONSTONE DARK	128 - 131
MOONSTONE GREY	132 - 135
PIETROSA MARBLE	136 - 139
PIETROSA SAND	140 - 143
SANDSTORM WARM GREY	144 - 147
SAWNSTONE ANTRACITA	148 - 151
SAWNSTONE GREY	152 - 155

SUDBURY ANTRACITA	156 - 159
SUDBURY DARK GREY	160 - 163
SUDBURY LIGHT GREY	164 - 167

MONTAJ Installation	
ÇAKIL VEYA KUM ÜZERİNE MONTAJ <i>Laying On Gravel Or Sand</i>	177
ÇİMENLERE MONTAJ <i>Laying On Lawn</i>	175
YAPIŞTIRICI İLE UYGULAMA <i>Adhesive Installation</i>	179
YÜKSELTİLMİŞ AYAK SİSTEMİ ÜZERİNE KURULUM <i>Installation On Raised Pedestal System</i>	181

DÖŞEME SİSTEMLERİ Floor Systems	
AYAR ANAHTARI <i>Adjustment Wrench</i>	189
DEĞİŞTİRİLEBİLİR DERZ PİMLERİ <i>Replacable Spacers</i>	188
YANAL YÜZEY KAPLAMA <i>Side Panel</i>	188
YÜKSELTİLMİŞ DÖŞEME AYAĞI <i>Raised Floor Pedestal</i>	189
YÜKSELTİLMİŞ DÖŞEME SİSTEMİ <i>Raised Floor System</i>	182 - 187

TEKNİK BİLGİLER Technical Informations	
MIN. R11 KAYMA DİRENCİ TESTİ <i>Slip Resistance Measurement For Min. R11</i>	198
RENK TONU DEĞİŞİMİ <i>Color Shade Variation</i>	198
TEKNİK FAYDALAR <i>Technical Advantages</i>	197
TEKNİK BİLGİLER <i>Technical Informations</i>	196

PAKETLEME VE YÜKLEME DETAYI Packaging & Loading Details	
60x120x2 cm	190
60x60x2 cm	191
60x60x3 cm	192
30x60x3 cm	193
90x90x3 cm	194
80x80x2 cm	195

INDEX alfabetik / alphabetic

outdoor 20 mm & 30 mm



AITOS ANTRACITA

8 - 11



BLUE STONE GREY

36 - 36



CLAY WHITE

60 - 63



AITOS GREY

12 - 15



CALIZA ANTRACITA

40 - 43



CONCRETO ANTRACITA

64 - 67



ATERRA ANTRACITA

16 - 19



CALIZA GREY

44 - 47



CONCRETO GREY

68 - 71



ATERRA GREY

20 - 23



CLAY ANTRACITA

48 - 51



CROSSOVER ANTRACITA

72 - 75



BELGIUM STONE ANTRACITA

24 - 27



CLAY GREY

52 - 55



CROSSOVER BLANCO

76 - 79



BELGIUM STONE GREY

28 - 31



CLAY SAND

56 - 59



CROSSOVER GREY

80 - 83



BLUE STONE ANTRACITA

32 - 35



BELGIUM STONE GREY

28 - 31



EARTH ANTRACITA

84 - 87



EARTH GREY 88 - 91



MAJA IVORY 116 - 119



SANDSTORM WARM GREY 144 - 147



EARTH WARM GREY 92 - 95



MERCURY ANTRACITA 120 - 123



SAWNSTONE ANTRACITA 148 - 151

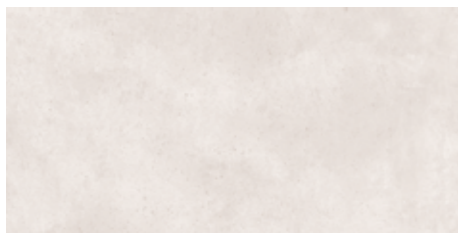

EARTH WHITE 96 - 99



MERCURY GREY 124 - 125



SAWNSTONE GREY 152 - 155



EPIRO ANTRACITA 100 - 103



MOONSTONE DARK GREY 128 - 131



SUDBURY ANTRACITA 156 - 159



EPIRO GREY 104 - 107



MOONSTONE GREY 132 - 135



SUDBURY DARK GREY 160 - 163



GRAVEL ANTRACITA 108 - 111



PIETROSA MARBLE 136 - 139



MOONSTONE LIGHT GREY 164 - 167



GRAVEL GREY 112 - 115



PIETROSA SAND 140 - 143



AUMA OAK 168 - 169

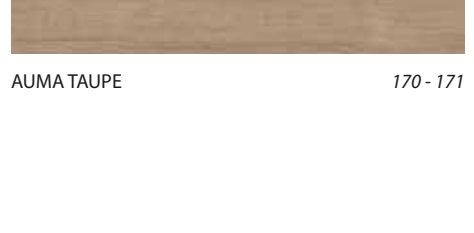

AUMA TAUPE 170 - 171

RENK COLOR

Geniş renk yelpazesi ile dış mekanları
dizayn edin.

*Design your outdoor spaces with a
wide range of colors.*

outdoor 20 mm & 30 mm



EBAT SIZE

Dış mekan tasarımları için 8 ebat ve modüler yaklaşımlar...

8 sizes and a modular approach for outdoor design.

60x120

30x120

90x90

45x90

40x80

80x80

30x60

60x60

outdoor 20 mm & 30 mm

AITOS ANTRACITA

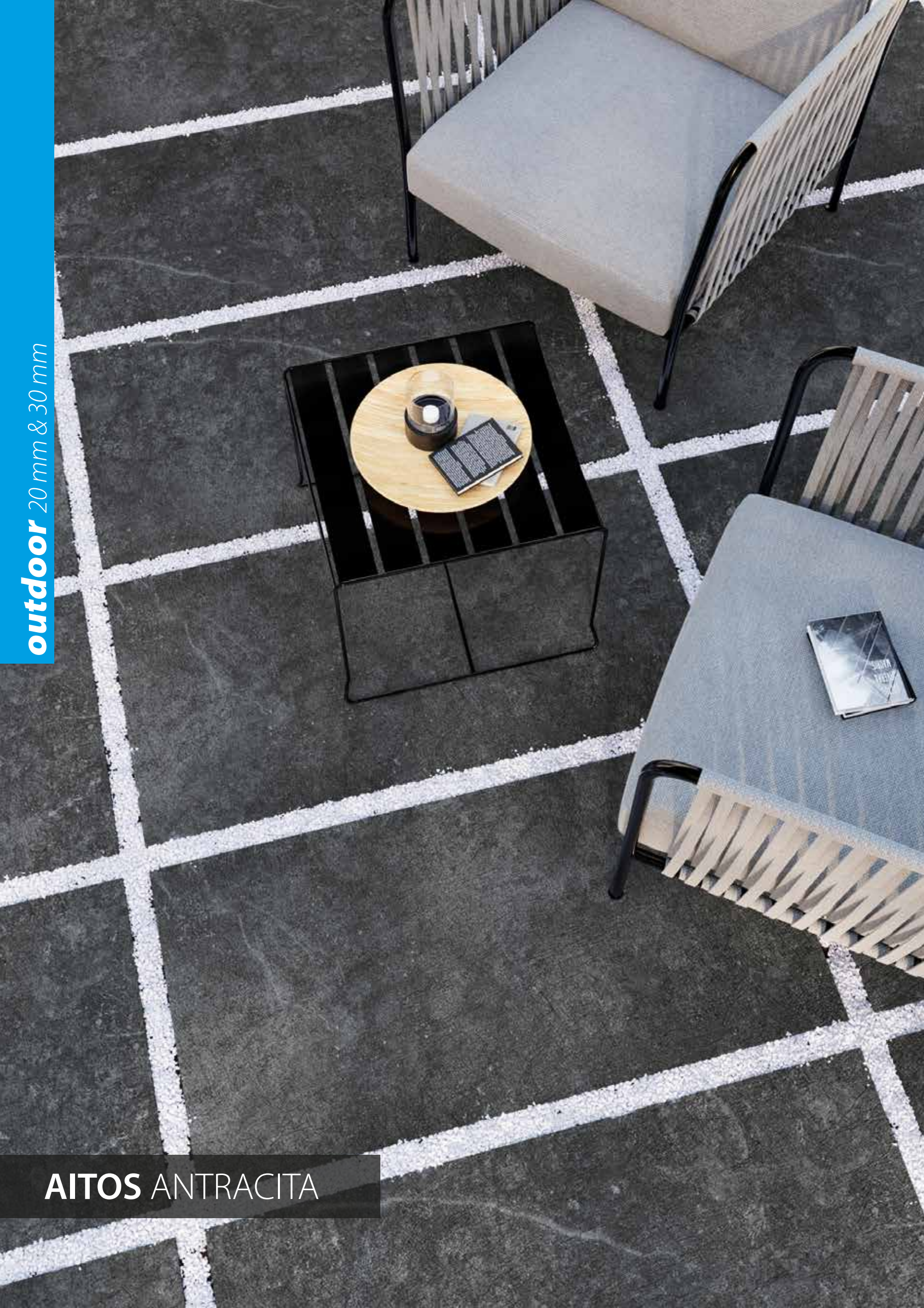

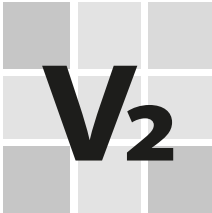
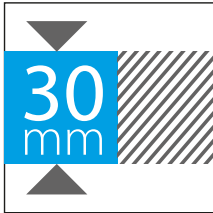

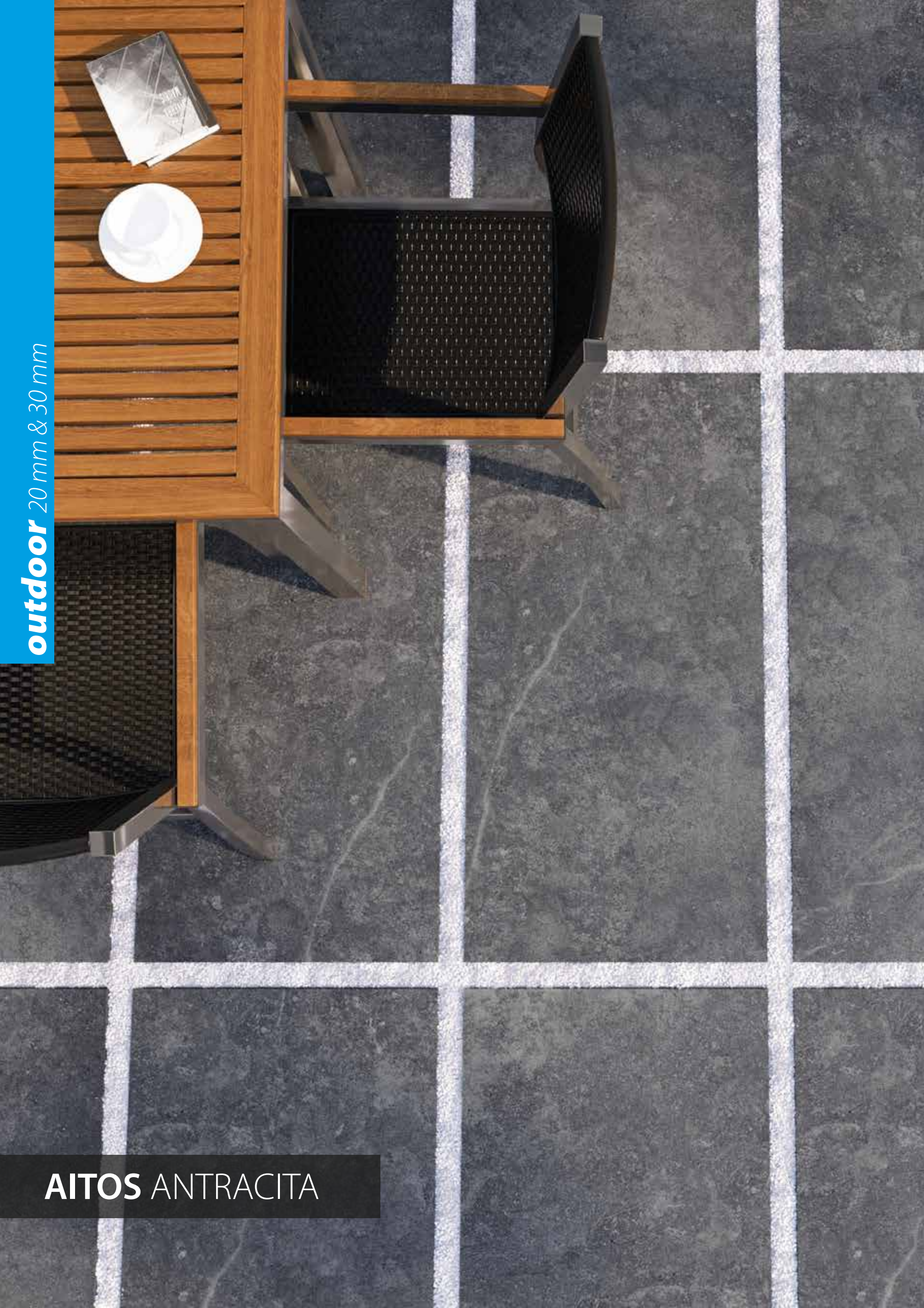

outdoor 20 mm & 30 mm

AITOS ANTRACITA

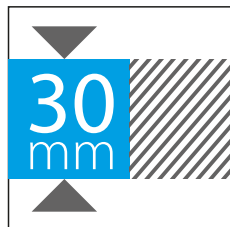
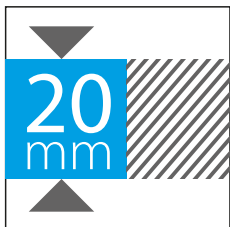
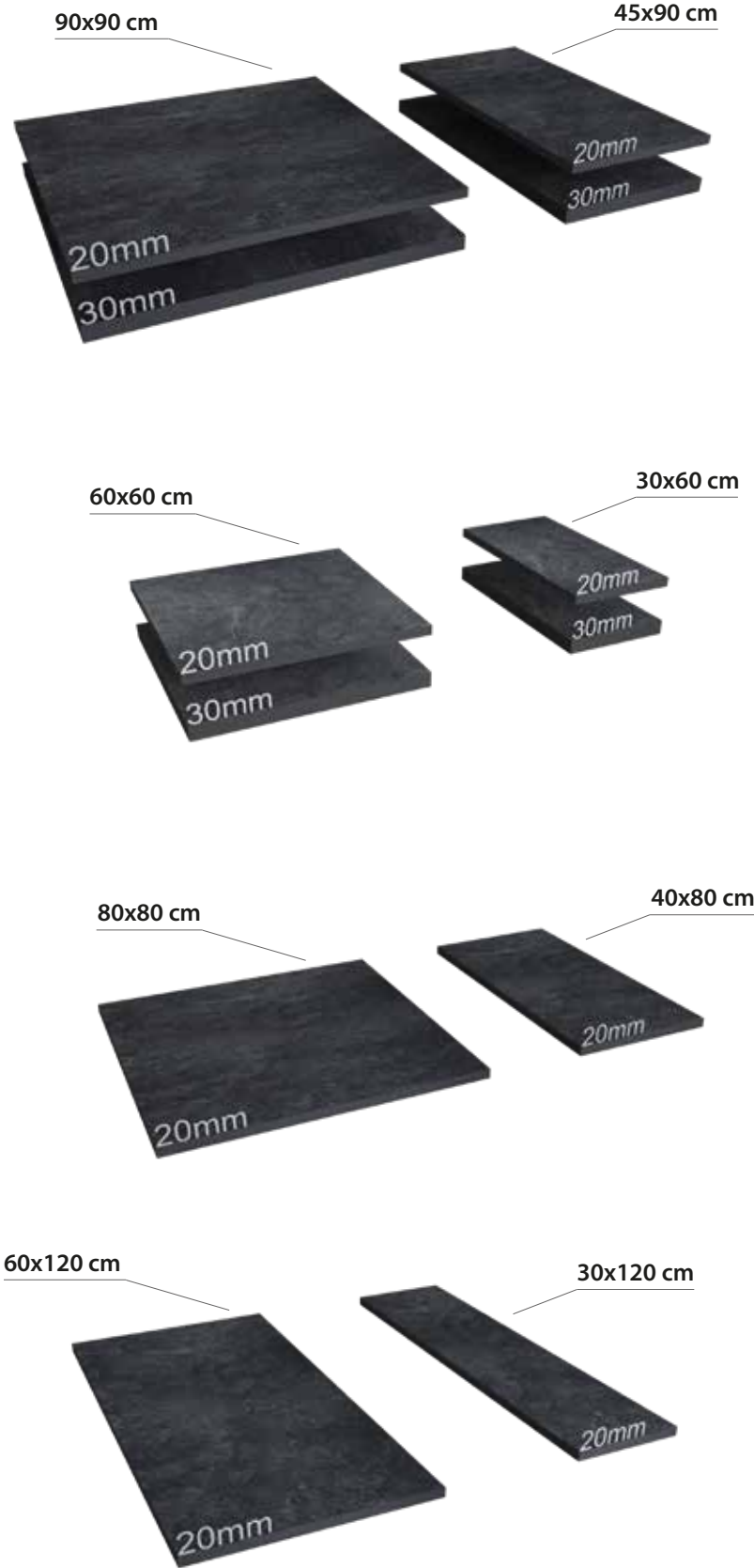

Kalınlık / Thickness: 20 mm

EBAT Sizes	ÜRÜN KODU Product Code	FIYAT Price Code	YÜZEY Surfaces
30x120 cm 12"x48"	312069468	F106	R9 FLAT
	312067968	F107	R11 FLAT
	312069368	F107	R13 RELIEF
30x60 cm 12"x24"	112069468	F108	R9 FLAT
	112067968	F109	R11 FLAT
	112069368	F109	R13 RELIEF
40x80 cm 16"x32"	712069468	F110	R9 FLAT
	712067968	F111	R11 FLAT
45x90 cm 18"x36"	812069468	F112	R9 FLAT
	812067968	F113	R11 FLAT
60x120 cm 24"x48"	302069468	F101	R9 FLAT
	302067968	F103	R11 FLAT
	302069368	F103	R13 RELIEF
60x60 cm 24"x24"	102069468	F100	R9 FLAT
	102067968	F102	R11 FLAT
	102069368	F102	R13 RELIEF
80x80 cm 32"x32"	702069468	F104	R9 FLAT
	702067968	F105	R11 FLAT
90x90 cm 36"x36"	802069468	F114	R9 FLAT
	802067968	F115	R11 FLAT

Kalınlık / Thickness: 30 mm

EBAT Sizes	ÜRÜN KODU Product Code	FIYAT Price Code	YÜZEY Surfaces
30x60 cm 12"x24"	113069468	F118	R9 FLAT
	113067968	F119	R11 FLAT
45x90 cm 18"x36"	813069468	F122	R9 FLAT
	813067968	F123	R11 FLAT
60x60 cm 24"x24"	103069468	F116	R9 FLAT
	103067968	F117	R11 FLAT
90x90 cm 36"x36"	803069468	F120	R9 FLAT
	803067968	F121	R11 FLAT

R13 - RELIEF

R9 - R11 - FLAT

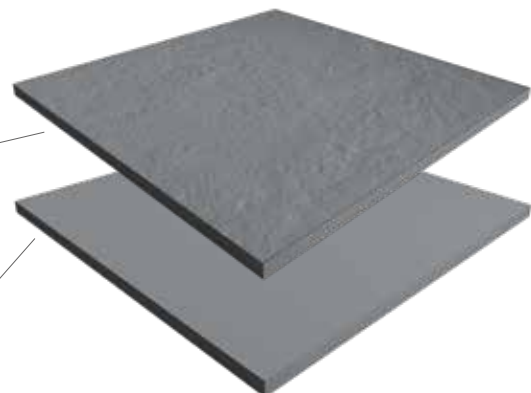



outdoor 20 mm & 30 mm

AITOS GREY

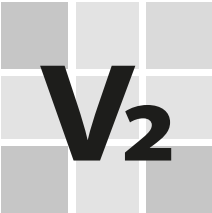
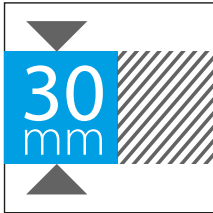



outdoor 20 mm & 30 mm

AITOS GREY

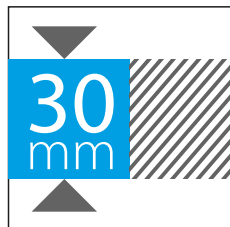
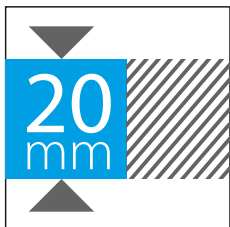
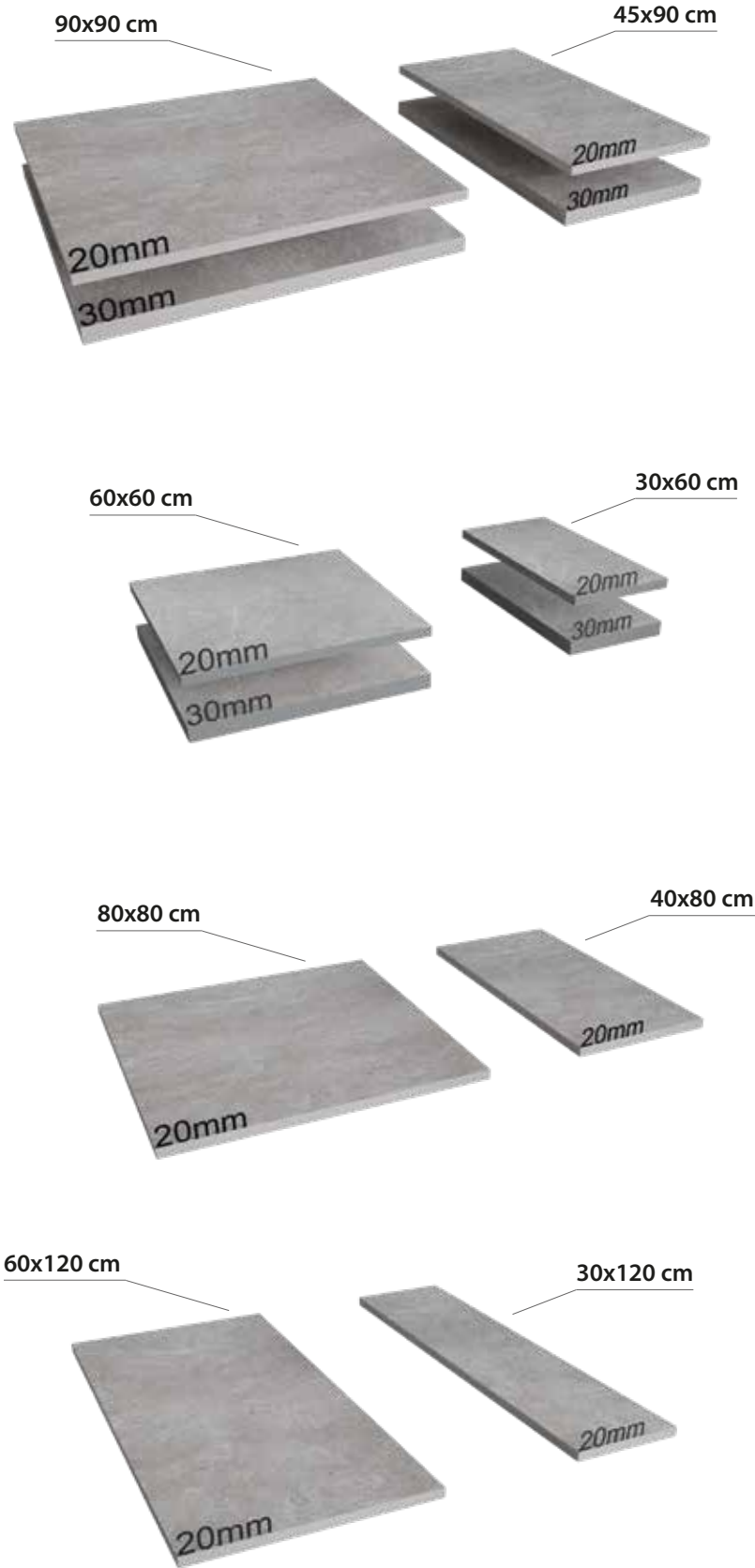

Kalınlık / Thickness: 20 mm

EBAT Sizes	ÜRÜN KODU Product Code	FIYAT Price Code	YÜZEY Surfaces
30x120 cm 12"x48"	312069409	F106	R9 FLAT
	312067909	F107	R11 FLAT
	312069309	F107	R13 RELIEF
30x60 cm 12"x24"	112069409	F108	R9 FLAT
	112067909	F109	R11 FLAT
	112069309	F109	R13 RELIEF
40x80 cm 16"x32"	712069409	F110	R9 FLAT
	712067909	F111	R11 FLAT
45x90 cm 18"x36"	812069409	F112	R9 FLAT
	812067909	F113	R11 FLAT
60x120 cm 24"x48"	302069409	F101	R9 FLAT
	302067909	F103	R11 FLAT
	302069309	F103	R13 RELIEF
60x60 cm 24"x24"	102069409	F100	R9 FLAT
	102067909	F102	R11 FLAT
	102069309	F102	R13 RELIEF
80x80 cm 32"x32"	702069409	F104	R9 FLAT
	702067909	F105	R11 FLAT
90x90 cm 36"x36"	802069409	F114	R9 FLAT
	802067909	F115	R11 FLAT

Kalınlık / Thickness: 30 mm

EBAT Sizes	ÜRÜN KODU Product Code	FIYAT Price Code	YÜZEY Surfaces
30x60 cm 12"x24"	113069409	F118	R9 FLAT
	113067909	F119	R11 FLAT
45x90 cm 18"x36"	813069409	F122	R9 FLAT
	813067909	F123	R11 FLAT
60x60 cm 24"x24"	103069409	F116	R9 FLAT
	103067909	F117	R11 FLAT
90x90 cm 36"x36"	803069409	F120	R9 FLAT
	803067909	F121	R11 FLAT

R13 - RELIEF

R9 - R11 - FLAT

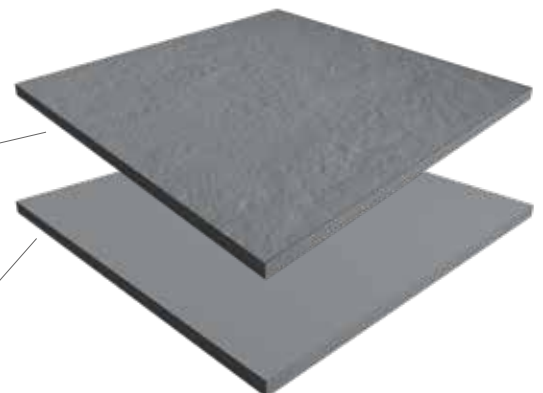

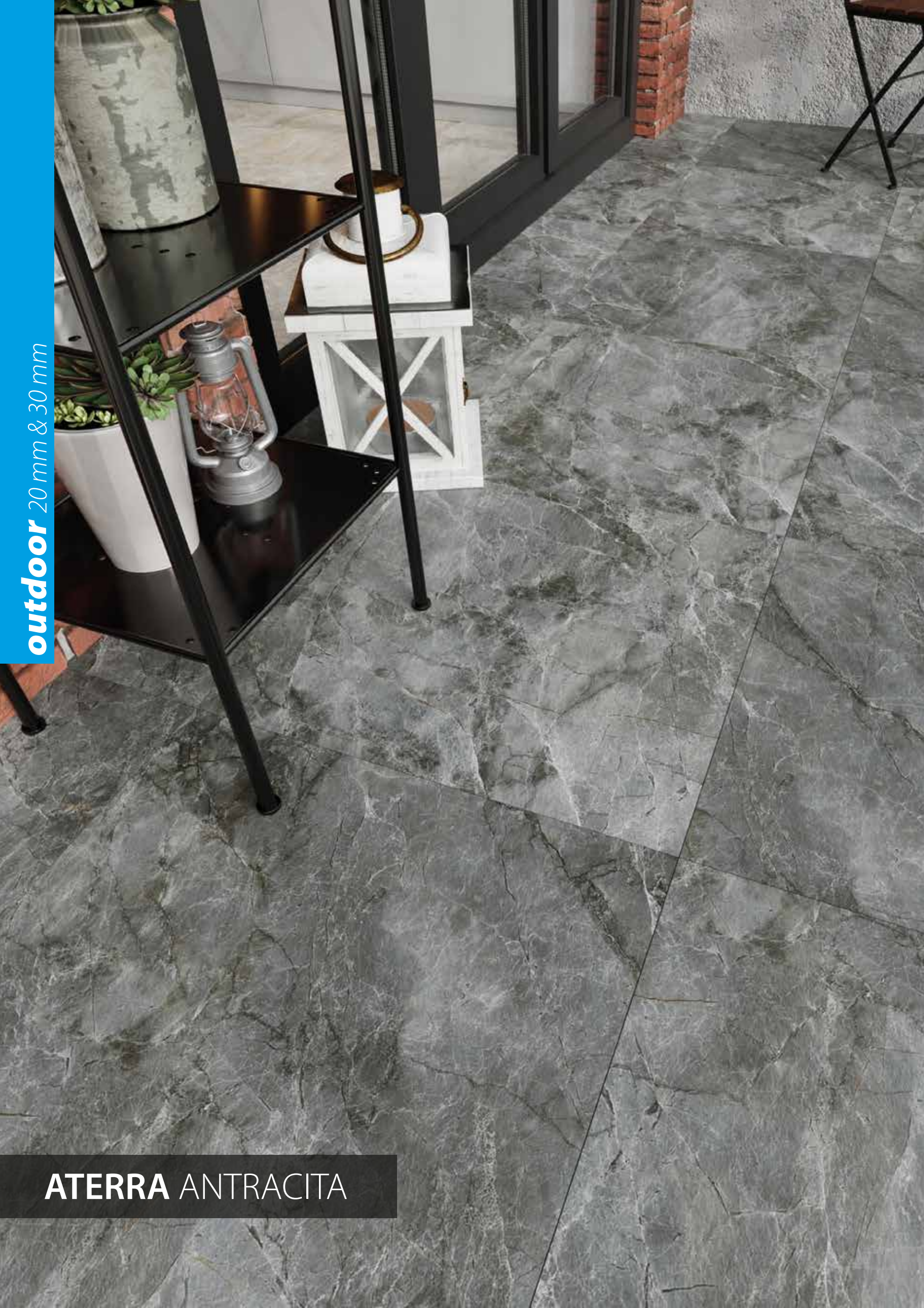

outdoor 20 mm & 30 mm

ATERRA ANTRACITA

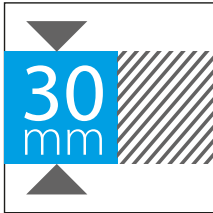

outdoor 20 mm & 30 mm

ATERRA ANTRACITA



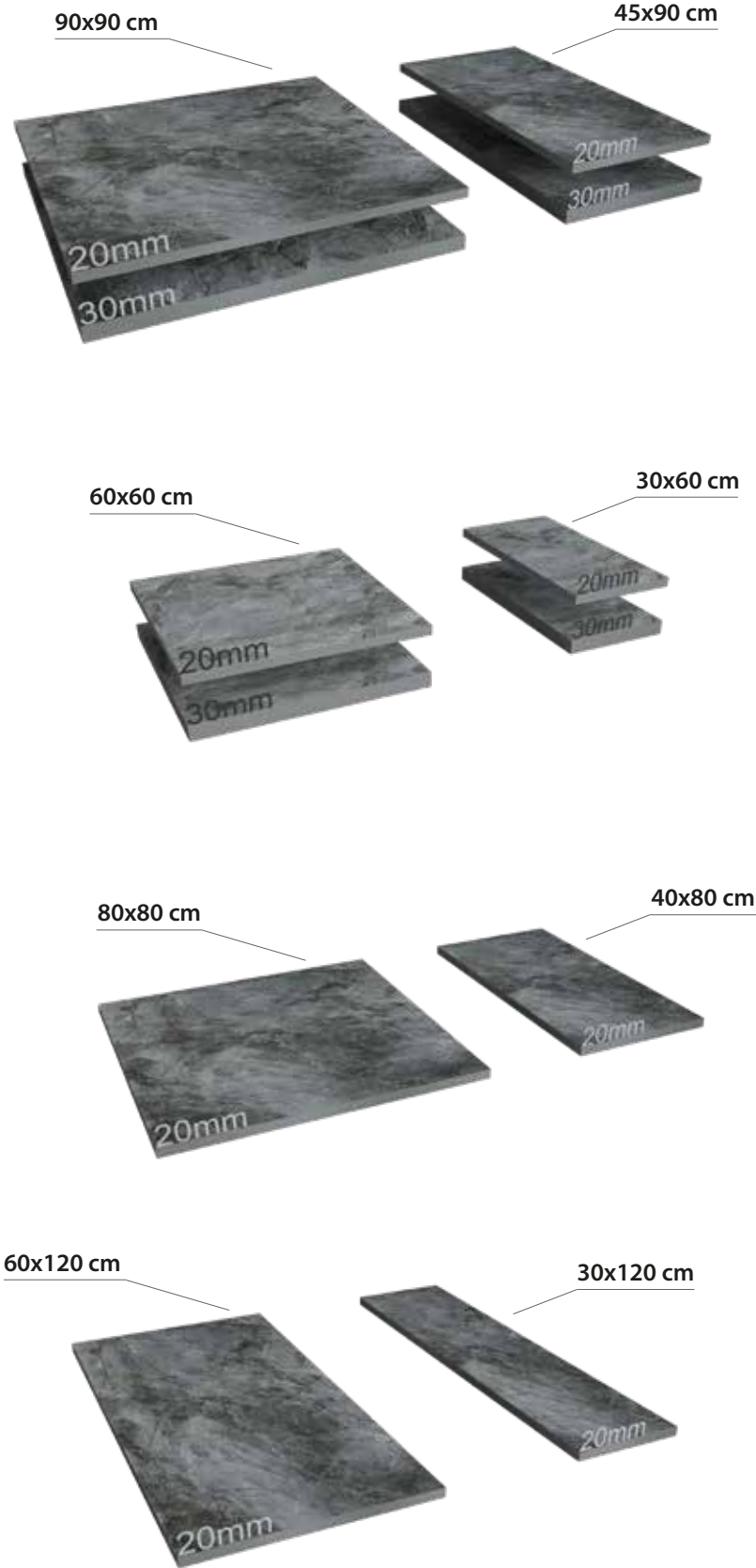

Kalınlık / Thickness: 20 mm

EBAT Sizes	ÜRÜN KODU Product Code	FIYAT Price Code	YÜZEY Surfaces
30x120 cm 12"x48"	312057868	F106	R9 FLAT
	312068068	F107	R11 FLAT
	312068468	F107	R13 RELIEF
30x60 cm 12"x24"	112057868	F108	R9 FLAT
	112068068	F109	R11 FLAT
	112068468	F109	R13 RELIEF
40x80 cm 16"x32"	712057868	F110	R9 FLAT
	712068068	F111	R11 FLAT
45x90 cm 18"x36"	812057868	F112	R9 FLAT
	812068068	F113	R11 FLAT
60x120 cm 24"x48"	302057868	F101	R9 FLAT
	302068068	F103	R11 FLAT
	302068468	F103	R13 RELIEF
60x60 cm 24"x24"	102057868	F100	R9 FLAT
	102068068	F102	R11 FLAT
	102068468	F102	R13 RELIEF
80x80 cm 32"x32"	702057868	F104	R9 FLAT
	702068068	F105	R11 FLAT
90x90 cm 36"x36"	802057868	F114	R9 FLAT
	802068068	F115	R11 FLAT

Kalınlık / Thickness: 30 mm

EBAT Sizes	ÜRÜN KODU Product Code	FIYAT Price Code	YÜZEY Surfaces
30x60 cm 12"x24"	113057868	F118	R9 FLAT
	113068068	F119	R11 FLAT
45x90 cm 18"x36"	813057868	F122	R9 FLAT
	813068068	F123	R11 FLAT
60x60 cm 24"x24"	103057868	F116	R9 FLAT
	103068068	F117	R11 FLAT
90x90 cm 36"x36"	803057868	F120	R9 FLAT
	803068068	F121	R11 FLAT

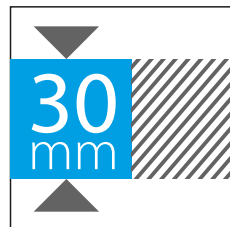
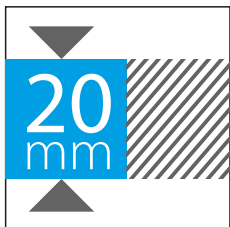

R13 - RELIEF

R9 - R11 - FLAT

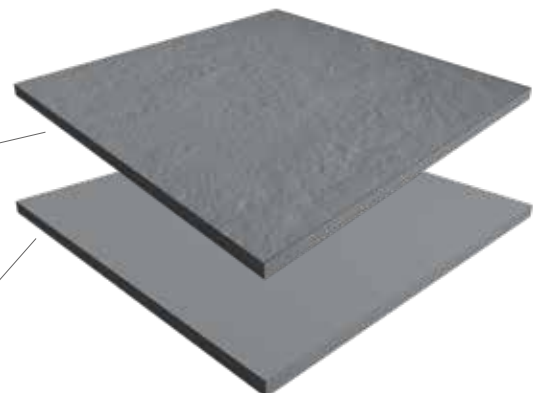

outdoor 20 mm & 30 mm



ATERRA GREY

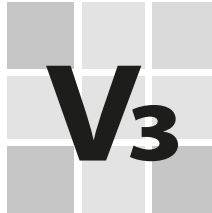
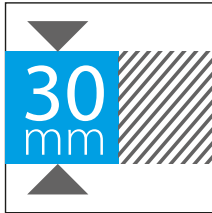



outdoor 20 mm & 30 mm

ATERRA GREY

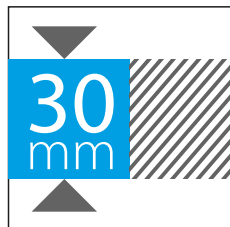
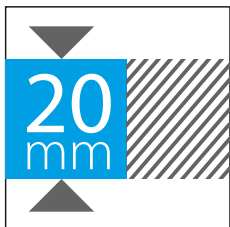
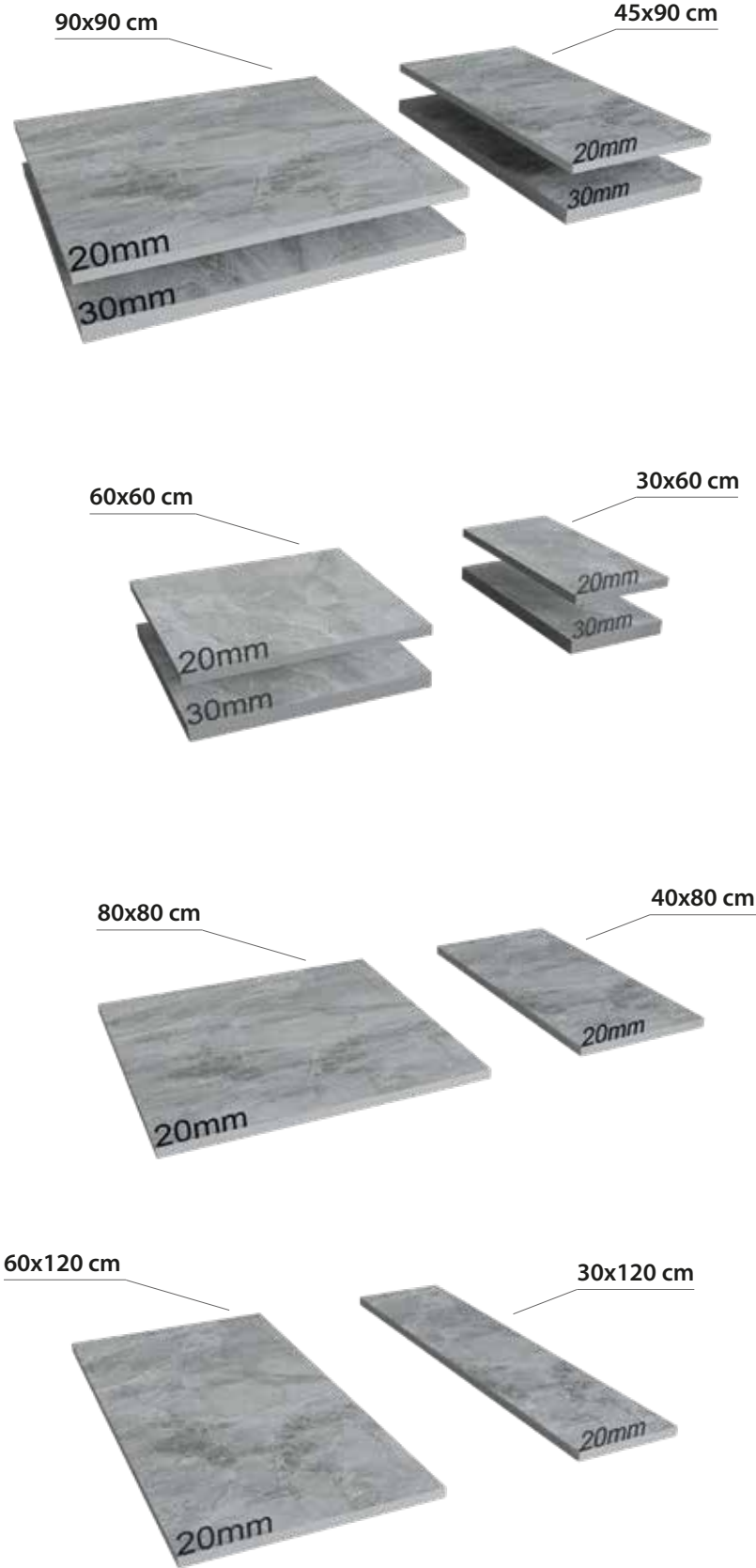

Kalınlık / Thickness: 20 mm

EBAT Sizes	ÜRÜN KODU Product Code	FIYAT Price Code	YÜZEY Surfaces
30x120 cm 12"x48"	312057809	F106	R9 FLAT
	312068009	F107	R11 FLAT
	312068409	F107	R13 RELIEF
30x60 cm 12"x24"	112057809	F108	R9 FLAT
	112068009	F109	R11 FLAT
	112068409	F109	R13 RELIEF
40x80 cm 16"x32"	712057809	F110	R9 FLAT
	712068009	F111	R11 FLAT
45x90 cm 18"x36"	812057809	F112	R9 FLAT
	812068009	F113	R11 FLAT
60x120 cm 24"x48"	302057809	F101	R9 FLAT
	302068009	F103	R11 FLAT
	302068409	F103	R13 RELIEF
60x60 cm 24"x24"	102057809	F100	R9 FLAT
	102068009	F102	R11 FLAT
	102068409	F102	R13 RELIEF
80x80 cm 32"x32"	702057809	F104	R9 FLAT
	702068009	F105	R11 FLAT
90x90 cm 36"x36"	802057809	F114	R9 FLAT
	802068009	F115	R11 FLAT

Kalınlık / Thickness: 30 mm

EBAT Sizes	ÜRÜN KODU Product Code	FIYAT Price Code	YÜZEY Surfaces
30x60 cm 12"x24"	113057809	F118	R9 FLAT
	113068009	F119	R11 FLAT
45x90 cm 18"x36"	813057809	F122	R9 FLAT
	813068009	F123	R11 FLAT
60x60 cm 24"x24"	103057809	F116	R9 FLAT
	103068009	F117	R11 FLAT
90x90 cm 36"x36"	803057809	F120	R9 FLAT
	803068009	F121	R11 FLAT

R13 - RELIEF

R9 - R11 - FLAT

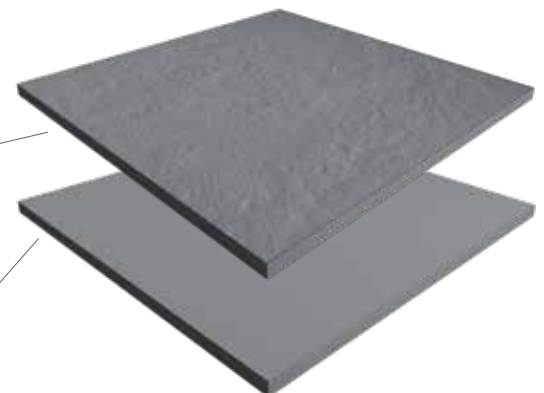

outdoor 20 mm & 30 mm

BELGIUM STONE ANTRACITA

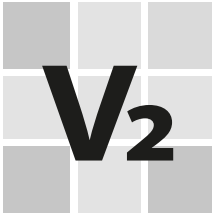
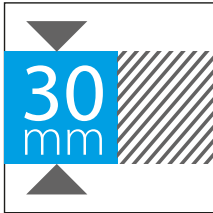



outdoor 20 mm & 30 mm

BELGIUM STONE ANTRACITA

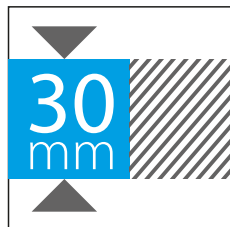
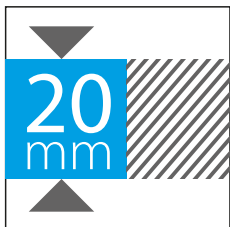
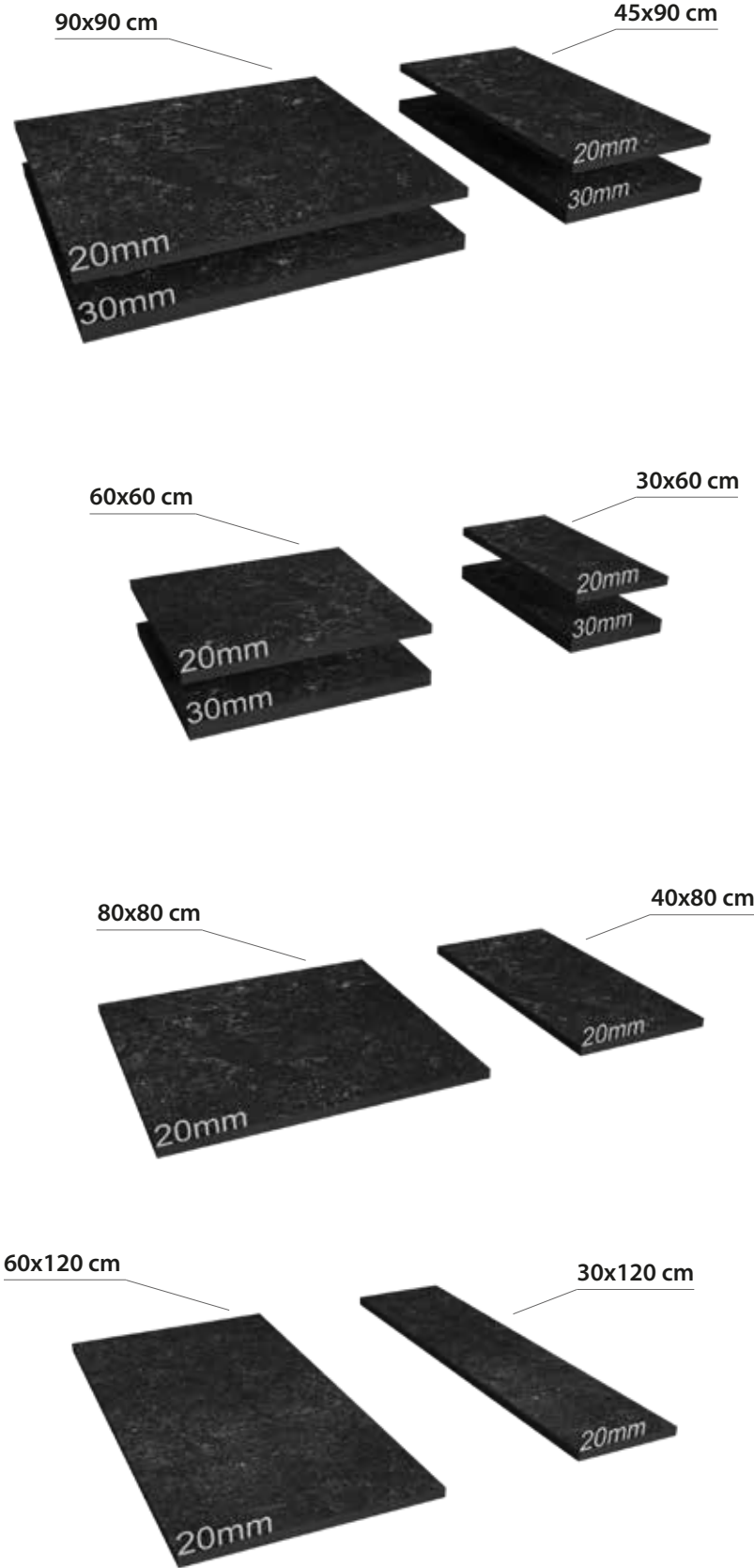

Kalınlık / Thickness: 20 mm

EBAT Sizes	ÜRÜN KODU Product Code	FIYAT Price Code	YÜZEY Surfaces
30x120 cm 12"x48"	312075168	F106	R9 FLAT
	312075268	F107	R11 FLAT
	312075068	F107	R13 RELIEF
30x60 cm 12"x24"	112075168	F108	R9 FLAT
	112075268	F109	R11 FLAT
	112075068	F109	R13 RELIEF
40x80 cm 16"x32"	712075168	F110	R9 FLAT
	712075268	F111	R11 FLAT
45x90 cm 18"x36"	812075168	F112	R9 FLAT
	812075268	F113	R11 FLAT
60x120 cm 24"x48"	302075168	F101	R9 FLAT
	302075268	F103	R11 FLAT
	302075068	F103	R13 RELIEF
60x60 cm 24"x24"	102075168	F100	R9 FLAT
	102075268	F102	R11 FLAT
	102075068	F102	R13 RELIEF
80x80 cm 32"x32"	702075168	F104	R9 FLAT
	702075268	F105	R11 FLAT
90x90 cm 36"x36"	802075168	F114	R9 FLAT
	802075268	F115	R11 FLAT

Kalınlık / Thickness: 30 mm

EBAT Sizes	ÜRÜN KODU Product Code	FIYAT Price Code	YÜZEY Surfaces
30x60 cm 12"x24"	113075168	F118	R9 FLAT
	113075268	F119	R11 FLAT
45x90 cm 18"x36"	813075168	F122	R9 FLAT
	813075268	F123	R11 FLAT
60x60 cm 24"x24"	103075168	F116	R9 FLAT
	103075268	F117	R11 FLAT
90x90 cm 36"x36"	803075168	F120	R9 FLAT
	803075268	F121	R11 FLAT

R13 - RELIEF

R9 - R11 - FLAT

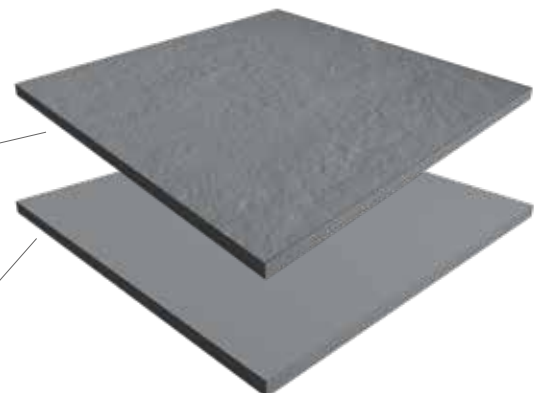



outdoor 20 mm & 30 mm

BELGIUM STONE GREY

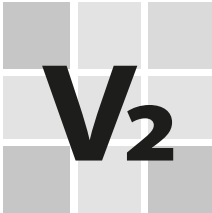
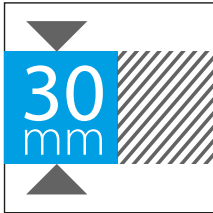

outdoor 20 mm & 30 mm

BELGIUM STONE GREY

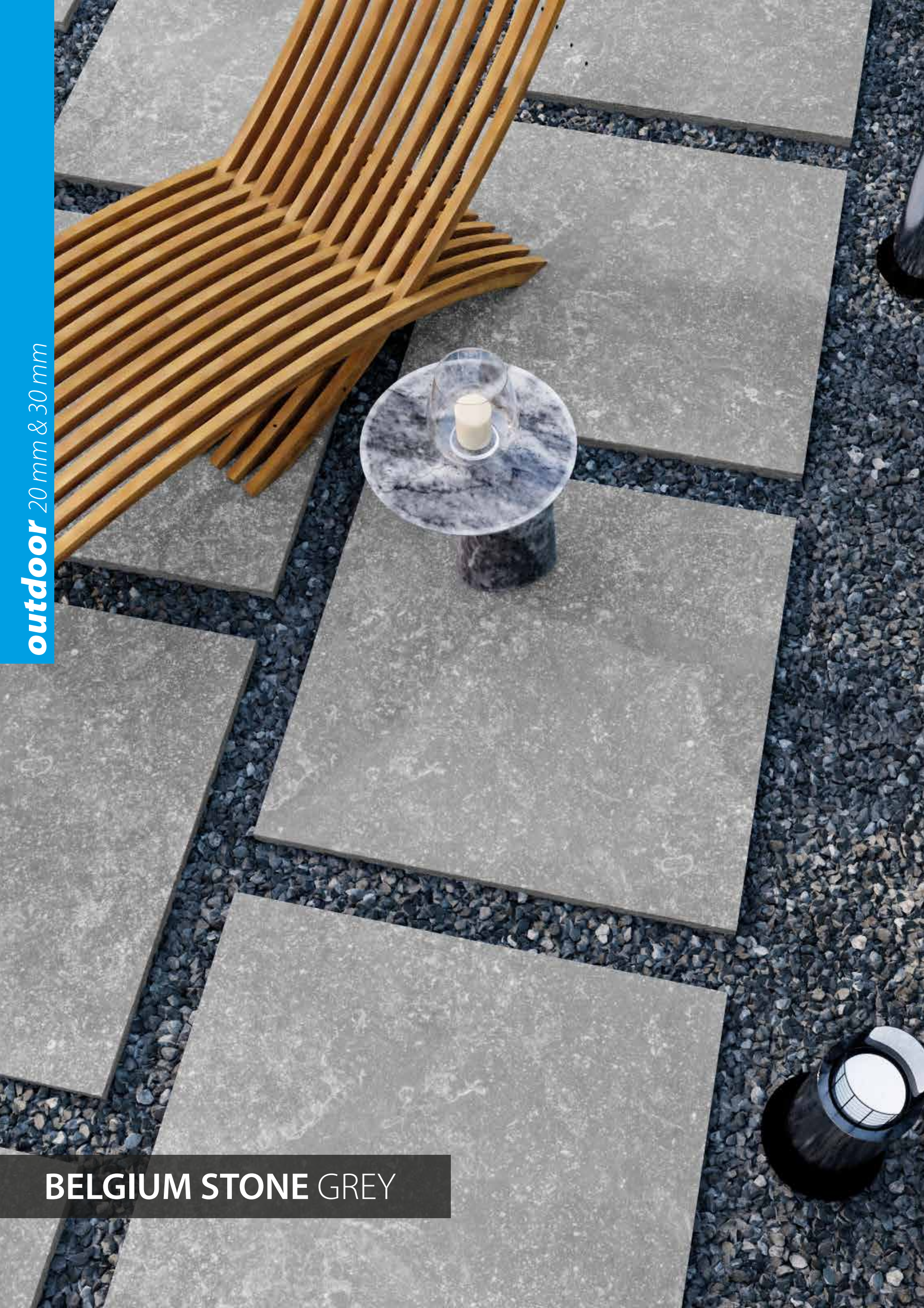

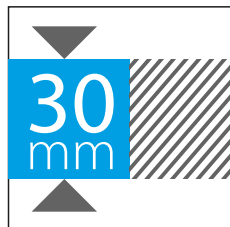
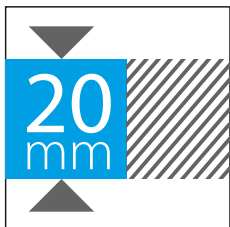
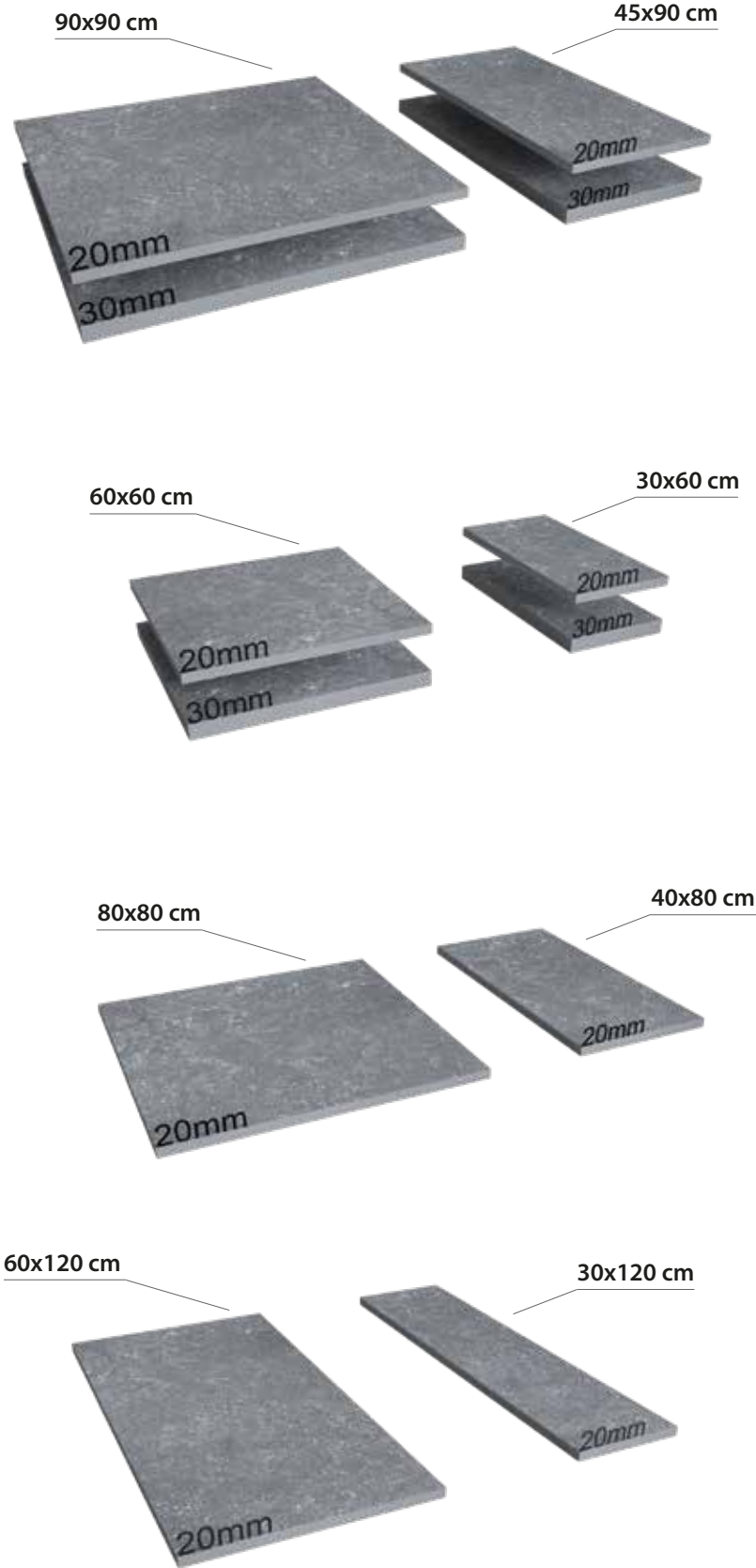

Kalınlık / Thickness: 20 mm

EBAT Sizes	ÜRÜN KODU Product Code	FIYAT Price Code	YÜZEY Surfaces
30x120 cm 12"x48"	312075109	F106	R9 FLAT
	312075209	F107	R11 FLAT
	312075009	F107	R13 RELIEF
30x60 cm 12"x24"	112075109	F108	R9 FLAT
	112075209	F109	R11 FLAT
	112075009	F109	R13 RELIEF
40x80 cm 16"x32"	712075109	F110	R9 FLAT
	712075209	F111	R11 FLAT
45x90 cm 18"x36"	812075109	F112	R9 FLAT
	812075209	F113	R11 FLAT
60x120 cm 24"x48"	302075109	F101	R9 FLAT
	302075209	F103	R11 FLAT
	302075009	F103	R13 RELIEF
60x60 cm 24"x24"	102075109	F100	R9 FLAT
	102075209	F102	R11 FLAT
	102075009	F102	R13 RELIEF
80x80 cm 32"x32"	702075109	F104	R9 FLAT
	702075209	F105	R11 FLAT
90x90 cm 36"x36"	802075109	F114	R9 FLAT
	802075209	F115	R11 FLAT

Kalınlık / Thickness: 30 mm

EBAT Sizes	ÜRÜN KODU Product Code	FIYAT Price Code	YÜZEY Surfaces
30x60 cm 12"x24"	113075109	F118	R9 FLAT
	113075209	F119	R11 FLAT
45x90 cm 18"x36"	813075109	F122	R9 FLAT
	813075209	F123	R11 FLAT
60x60 cm 24"x24"	103075109	F116	R9 FLAT
	103075209	F117	R11 FLAT
90x90 cm 36"x36"	803075109	F120	R9 FLAT
	803075209	F121	R11 FLAT

R13 - RELIEF

R9 - R11 - FLAT

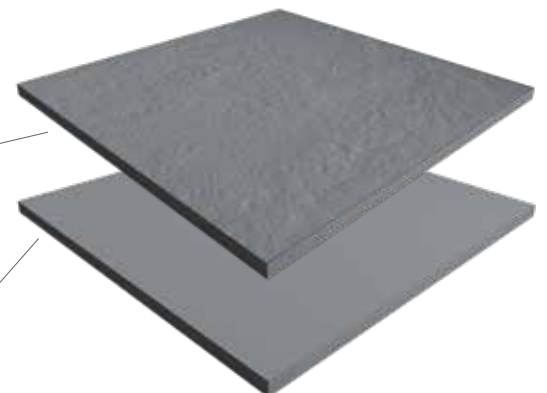



outdoor 20 mm & 30 mm

BLUESTONE ANTRACITA

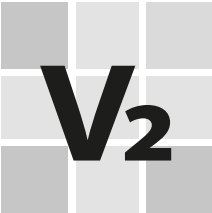
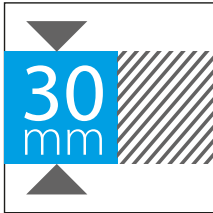
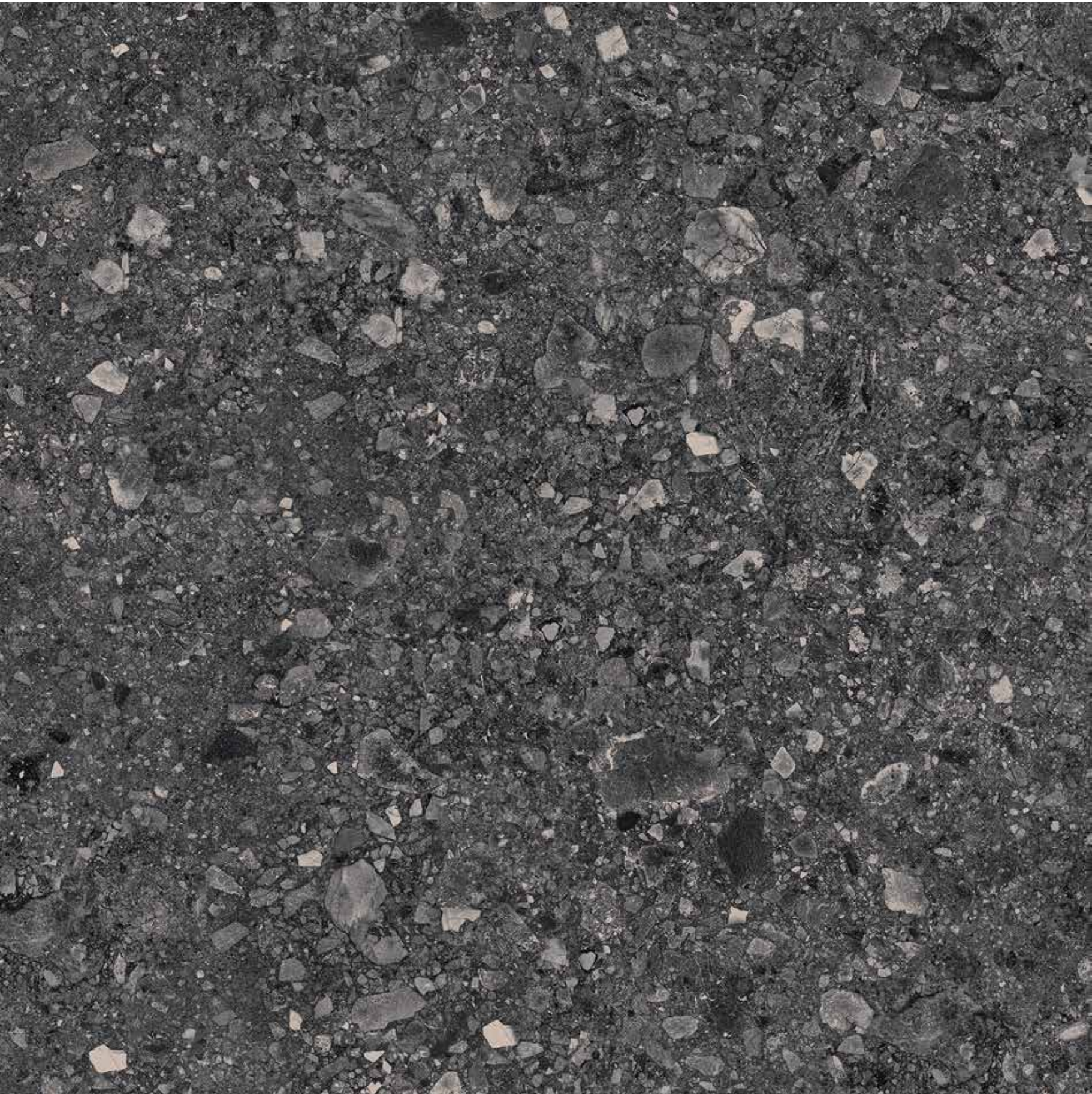



outdoor 20 mm & 30 mm

BLUESTONE ANTRACITA

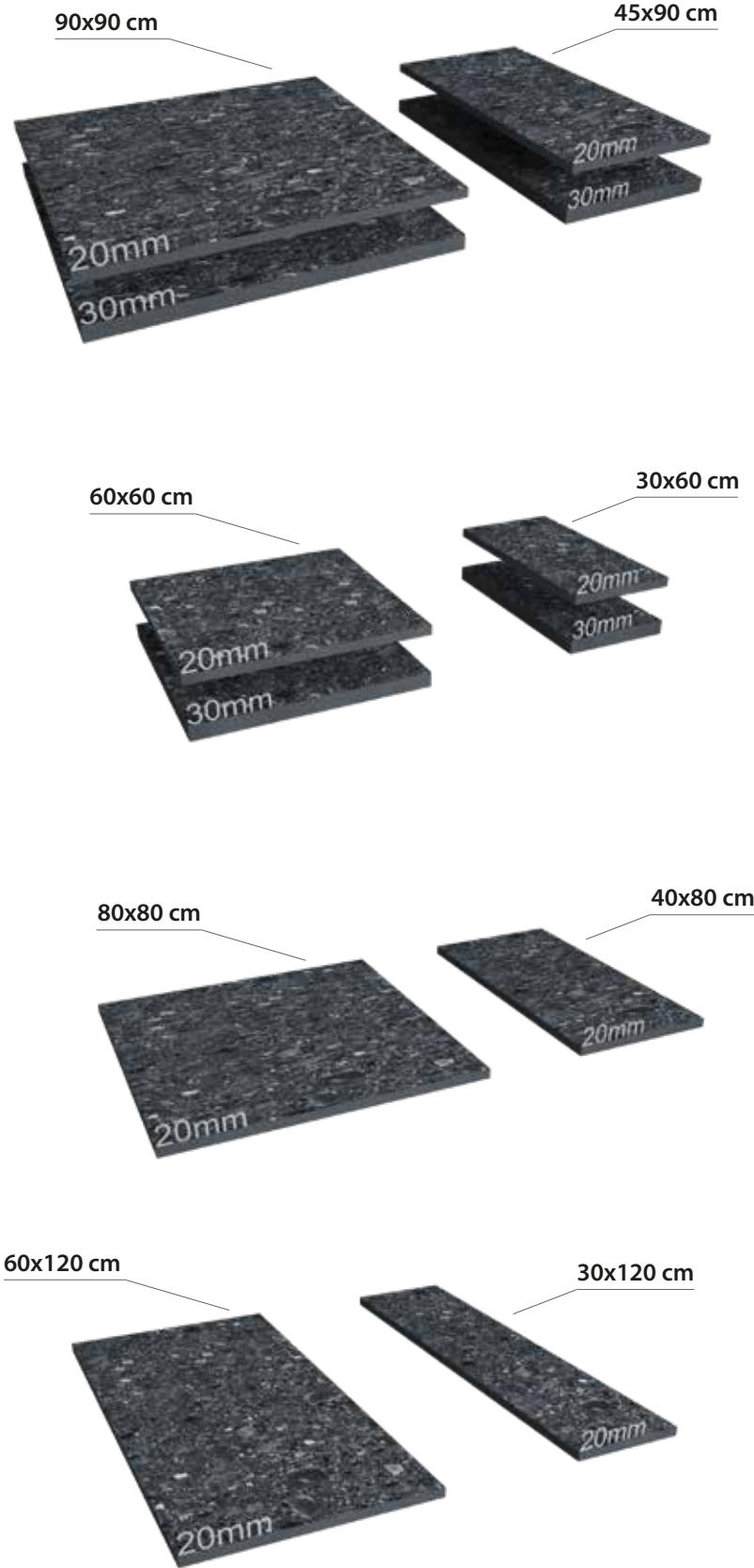

Kalınlık / Thickness: 20 mm

EBAT Sizes	ÜRÜN KODU Product Code	FIYAT Price Code	YÜZEY Surfaces
30x120 cm 12"x48"	312063268	F106	R9 FLAT
	312067668	F107	R11 FLAT
	312068968	F107	R13 RELIEF
30x60 cm 12"x24"	112063268	F108	R9 FLAT
	112067668	F109	R11 FLAT
	112068968	F109	R13 RELIEF
40x80 cm 16"x32"	712063268	F110	R9 FLAT
	712067668	F111	R11 FLAT
45x90 cm 18"x36"	812063268	F112	R9 FLAT
	812067668	F113	R11 FLAT
60x120 cm 24"x48"	302063268	F101	R9 FLAT
	302067668	F103	R11 FLAT
	302068968	F103	R13 RELIEF
60x60 cm 24"x24"	102063268	F100	R9 FLAT
	102067668	F102	R11 FLAT
	102068968	F102	R13 RELIEF
80x80 cm 32"x32"	702063268	F104	R9 FLAT
	702067668	F105	R11 FLAT
90x90 cm 36"x36"	802063268	F114	R9 FLAT
	802067668	F115	R11 FLAT

Kalınlık / Thickness: 30 mm

EBAT Sizes	ÜRÜN KODU Product Code	FIYAT Price Code	YÜZEY Surfaces
30x60 cm 12"x24"	113063268	F118	R9 FLAT
	113067668	F119	R11 FLAT
	113068968	F119	R13 RELIEF
45x90 cm 18"x36"	813063268	F122	R9 FLAT
	813067668	F123	R11 FLAT
60x60 cm 24"x24"	103063268	F116	R9 FLAT
	103067668	F117	R11 FLAT
	103068968	F117	R13 RELIEF
90x90 cm 36"x36"	803063268	F120	R9 FLAT
	803067668	F121	R11 FLAT

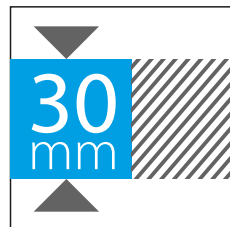
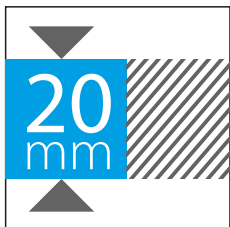

R13 - RELIEF

R9 - R11 - FLAT

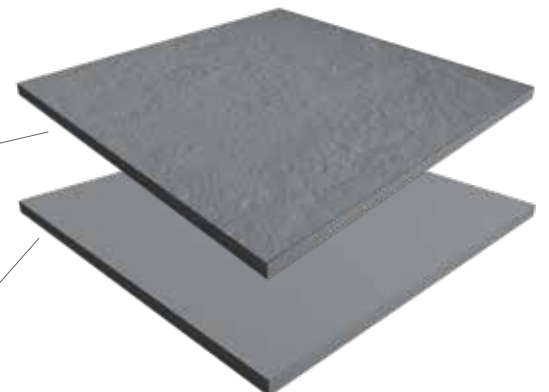

outdoor 20 mm & 30 mm

BLUESTONE GREY



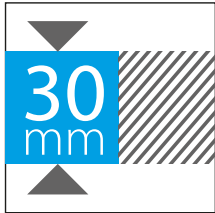
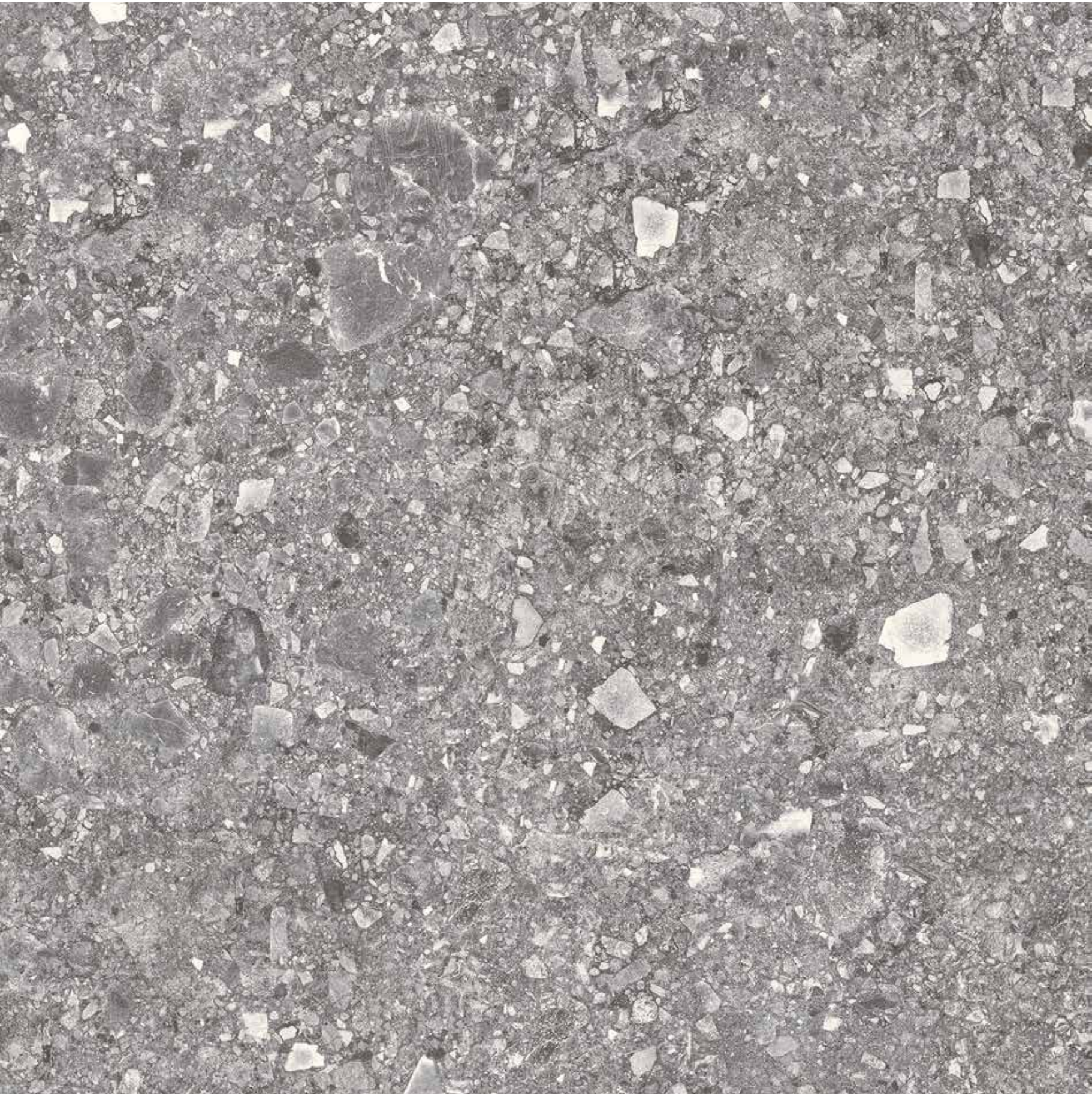



outdoor 20 mm & 30 mm

BLUESTONE GREY

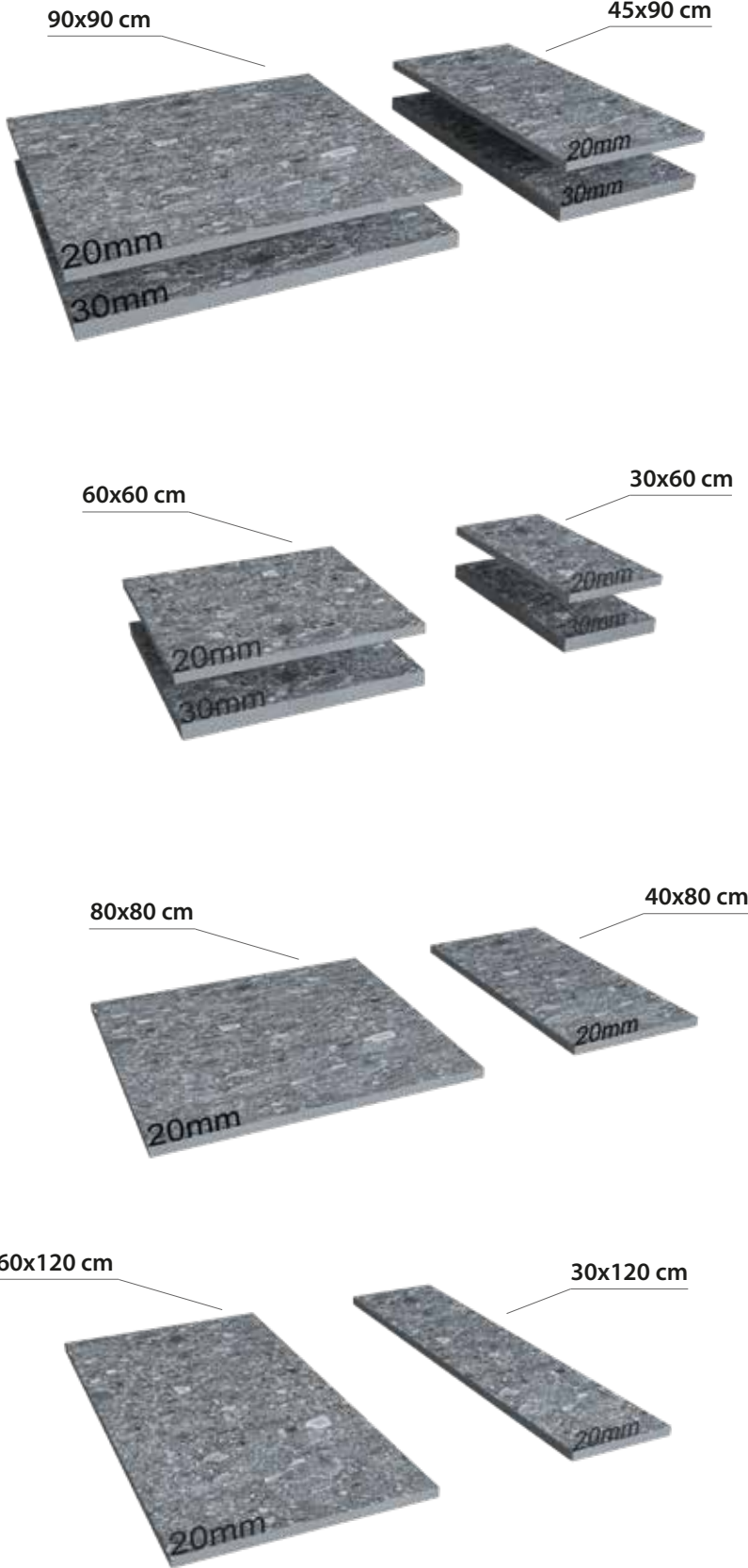

Kalınlık / Thickness: 20 mm

EBAT Sizes	ÜRÜN KODU Product Code	FIYAT Price Code	YÜZEY Surfaces
30x120 cm 12"x48"	312063209	F106	R9 FLAT
	312067609	F107	R11 FLAT
	312068909	F107	R13 RELIEF
30x60 cm 12"x24"	112063209	F108	R9 FLAT
	112067609	F109	R11 FLAT
	112068909	F109	R13 RELIEF
40x80 cm 16"x32"	712063209	F110	R9 FLAT
	712067609	F111	R11 FLAT
45x90 cm 18"x36"	812063209	F112	R9 FLAT
	812067609	F113	R11 FLAT
60x120 cm 24"x48"	302063209	F101	R9 FLAT
	302067609	F103	R11 FLAT
	302068909	F103	R13 RELIEF
60x60 cm 24"x24"	102063209	F100	R9 FLAT
	102067609	F102	R11 FLAT
	102068909	F102	R13 RELIEF
80x80 cm 32"x32"	702063209	F104	R9 FLAT
	702067609	F105	R11 FLAT
90x90 cm 36"x36"	802063209	F114	R9 FLAT
	802067609	F115	R11 FLAT

Kalınlık / Thickness: 30 mm

EBAT Sizes	ÜRÜN KODU Product Code	FIYAT Price Code	YÜZEY Surfaces
30x60 cm 12"x24"	113063209	F118	R9 FLAT
	113067609	F119	R11 FLAT
	113068909	F119	R13 RELIEF
45x90 cm 18"x36"	813063209	F122	R9 FLAT
	813067609	F123	R11 FLAT
60x60 cm 24"x24"	103063209	F116	R9 FLAT
	103067609	F117	R11 FLAT
	103068909	F117	R13 RELIEF
90x90 cm 36"x36"	803063209	F120	R9 FLAT
	803067609	F121	R11 FLAT

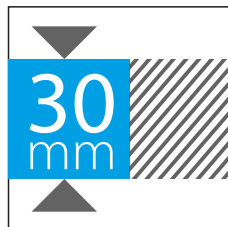
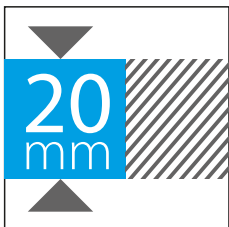

R13 - RELIEF

R9 - R11 - FLAT

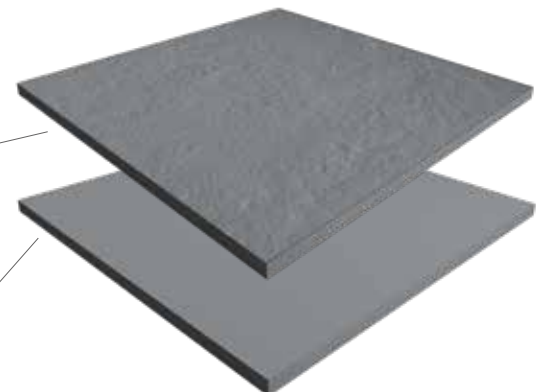

outdoor 20 mm & 30 mm

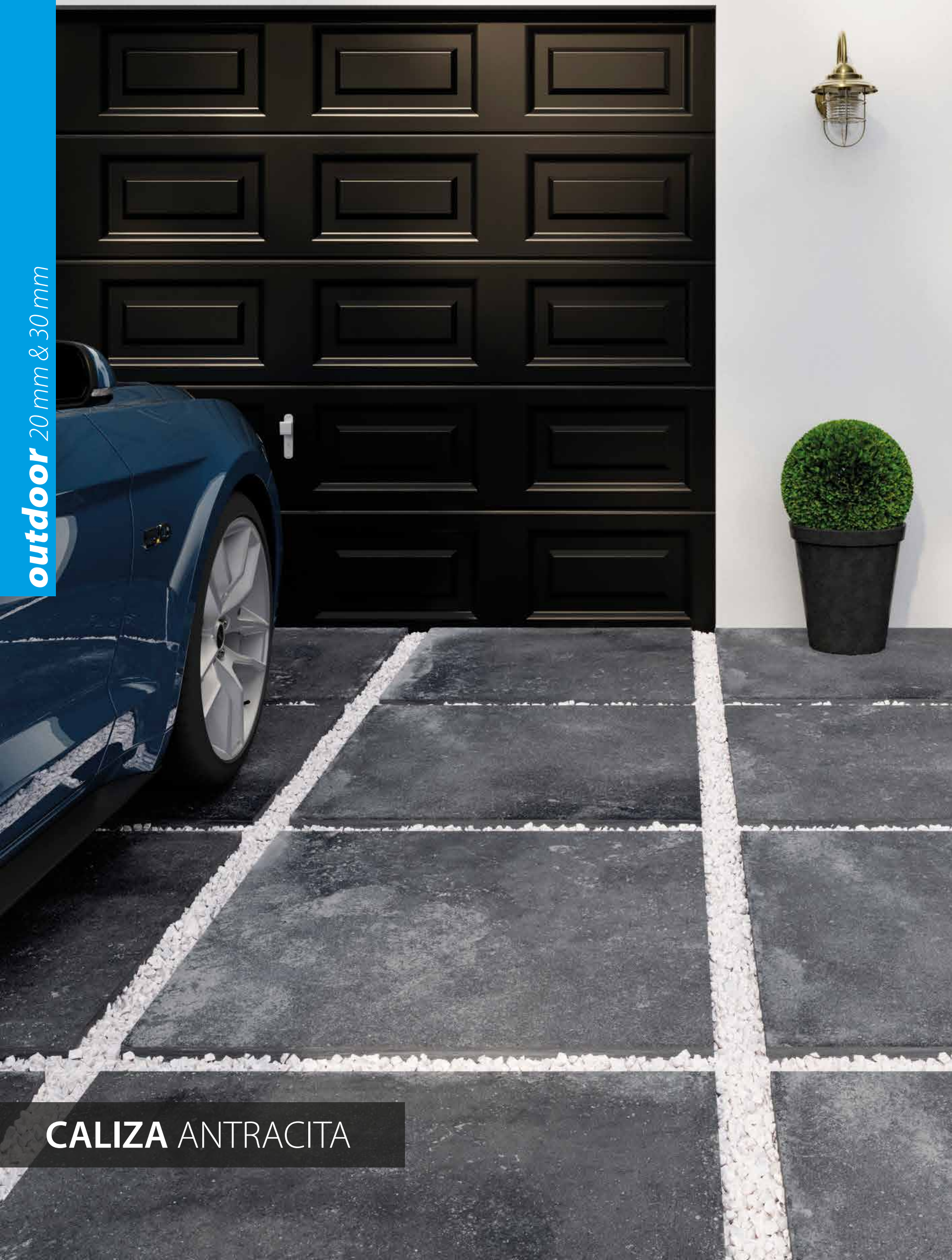

CALIZA ANTRACITA

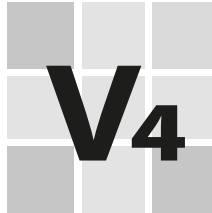
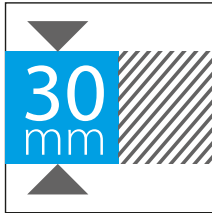

outdoor 20 mm & 30 mm



CALIZA ANTRACITA

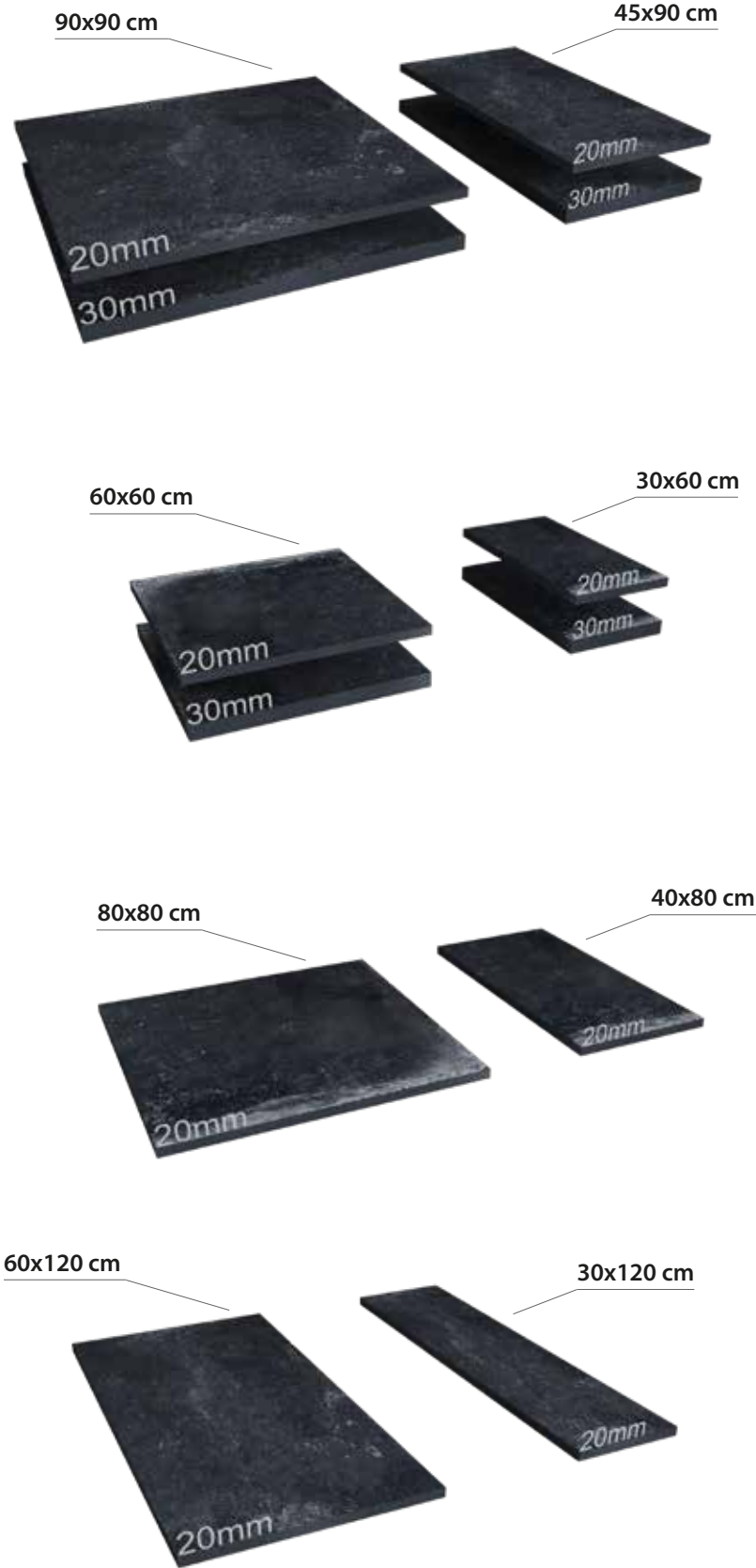

Kalınlık / Thickness: 20 mm

EBAT Sizes	ÜRÜN KODU Product Code	FIYAT Price Code	YÜZEY Surfaces
30x120 cm 12"x48"	312069968	F106	R9 FLAT
	312070068	F107	R11 FLAT
	312069868	F107	R13 RELIEF
30x60 cm 12"x24"	112069968	F108	R9 FLAT
	112070068	F109	R11 FLAT
	112069868	F109	R13 RELIEF
40x80 cm 16"x32"	712069968	F110	R9 FLAT
	712070068	F111	R11 FLAT
45x90 cm 18"x36"	812069968	F112	R9 FLAT
	812070068	F113	R11 FLAT
60x120 cm 24"x48"	302069968	F101	R9 FLAT
	302070068	F103	R11 FLAT
	302069868	F103	R13 RELIEF
60x60 cm 24"x24"	102069968	F100	R9 FLAT
	102070068	F102	R11 FLAT
	102069868	F102	R13 RELIEF
80x80 cm 32"x32"	702069968	F104	R9 FLAT
	702070068	F105	R11 FLAT
90x90 cm 36"x36"	802069968	F114	R9 FLAT
	802070068	F115	R11 FLAT

Kalınlık / Thickness: 30 mm

EBAT Sizes	ÜRÜN KODU Product Code	FIYAT Price Code	YÜZEY Surfaces
30x60 cm 12"x24"	113069968	F118	R9 FLAT
	113070068	F119	R11 FLAT
45x90 cm 18"x36"	813069968	F122	R9 FLAT
	813070068	F123	R11 FLAT
60x60 cm 24"x24"	103069968	F116	R9 FLAT
	103070068	F117	R11 FLAT
90x90 cm 36"x36"	803069968	F120	R9 FLAT
	803070068	F121	R11 FLAT

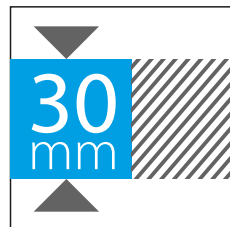
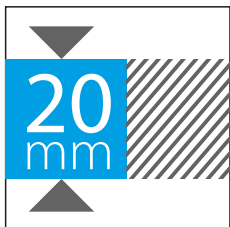

R13 - RELIEF

R9 - R11 - FLAT

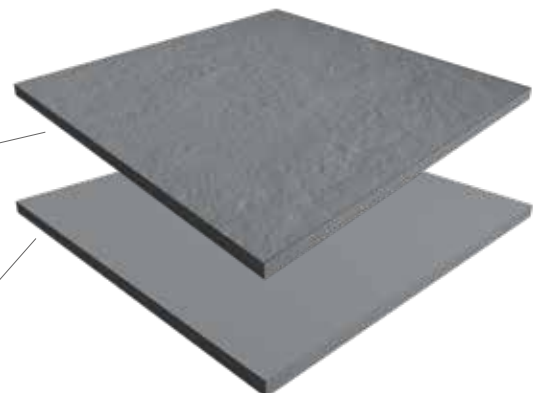



outdoor 20 mm & 30 mm

CALIZA GREY

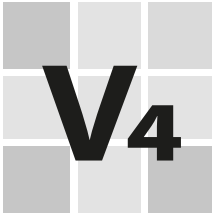
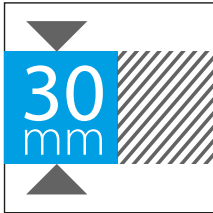

outdoor 20 mm & 30 mm

CALIZA GREY



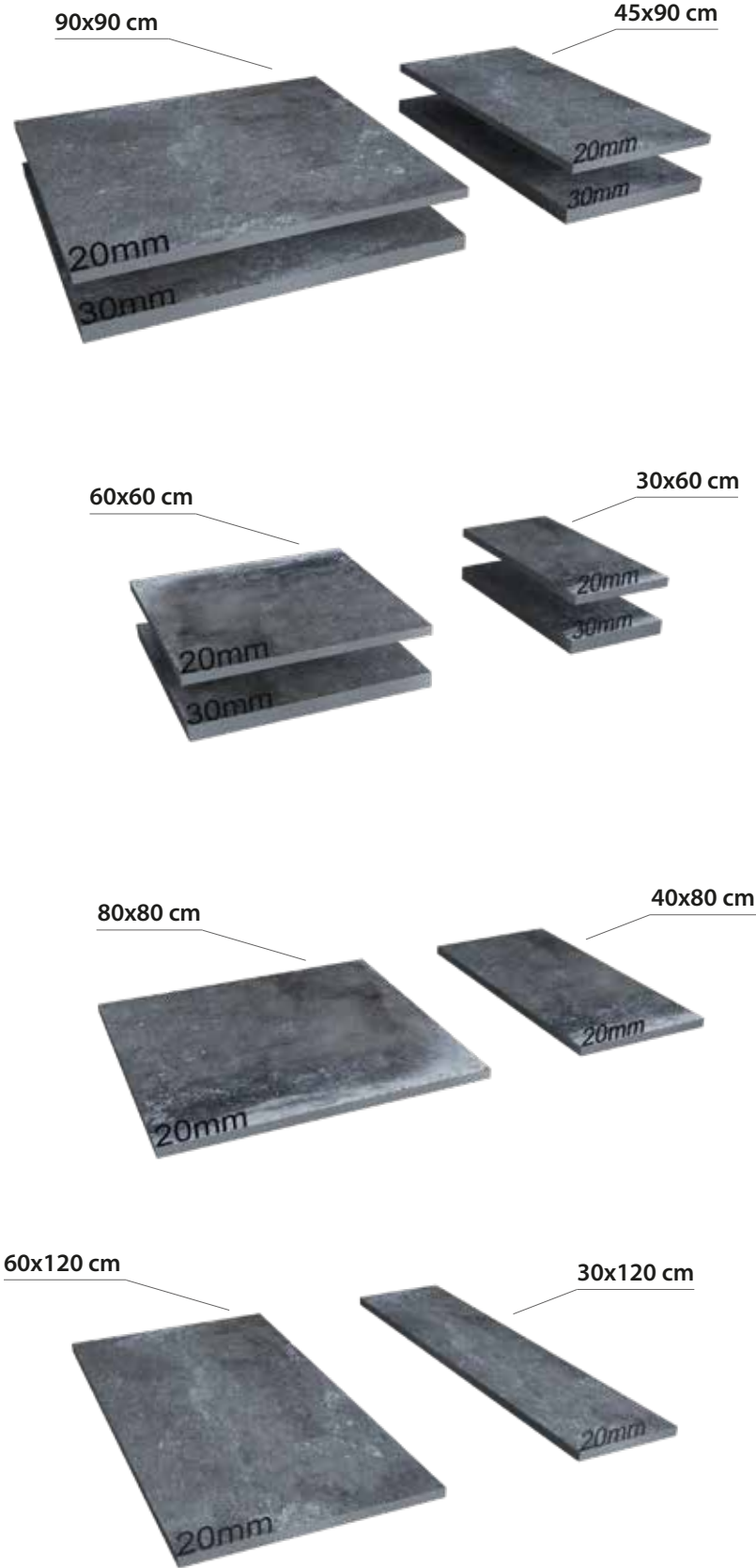

Kalınlık / Thickness: 20 mm

EBAT Sizes	ÜRÜN KODU Product Code	FIYAT Price Code	YÜZEY Surfaces
30x120 cm 12"x48"	312069909	F106	R9 FLAT
	312070009	F107	R11 FLAT
	312069809	F107	R13 RELIEF
30x60 cm 12"x24"	112069909	F108	R9 FLAT
	112070009	F109	R11 FLAT
	112069809	F109	R13 RELIEF
40x80 cm 16"x32"	712069909	F110	R9 FLAT
	712070009	F111	R11 FLAT
45x90 cm 18"x36"	812069909	F112	R9 FLAT
	812070009	F113	R11 FLAT
60x120 cm 24"x48"	302069909	F101	R9 FLAT
	302070009	F103	R11 FLAT
	302069809	F103	R13 RELIEF
60x60 cm 24"x24"	102069909	F100	R9 FLAT
	102070009	F102	R11 FLAT
	102069809	F102	R13 RELIEF
80x80 cm 32"x32"	702069909	F104	R9 FLAT
	702070009	F105	R11 FLAT
90x90 cm 36"x36"	802069909	F114	R9 FLAT
	802070009	F115	R11 FLAT

Kalınlık / Thickness: 30 mm

EBAT Sizes	ÜRÜN KODU Product Code	FIYAT Price Code	YÜZEY Surfaces
30x60 cm 12"x24"	113069909	F118	R9 FLAT
	113070009	F119	R11 FLAT
45x90 cm 18"x36"	813069909	F122	R9 FLAT
	813070009	F123	R11 FLAT
60x60 cm 24"x24"	103069909	F116	R9 FLAT
	103070009	F117	R11 FLAT
90x90 cm 36"x36"	803069909	F120	R9 FLAT
	803070009	F121	R11 FLAT

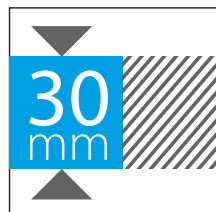

R13 - RELIEF

R9 - R11 - FLAT

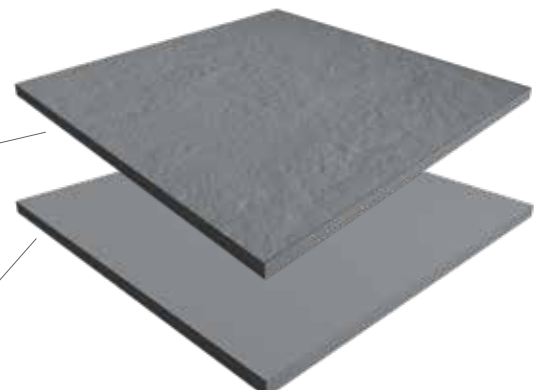

outdoor 20 mm & 30 mm

CLAY ANTRACITA

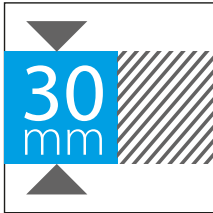



outdoor 20 mm & 30 mm

CLAY ANTRACITA

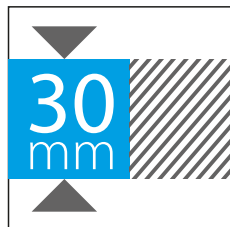
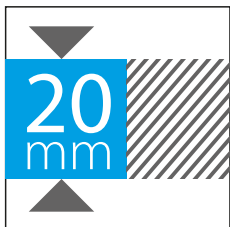
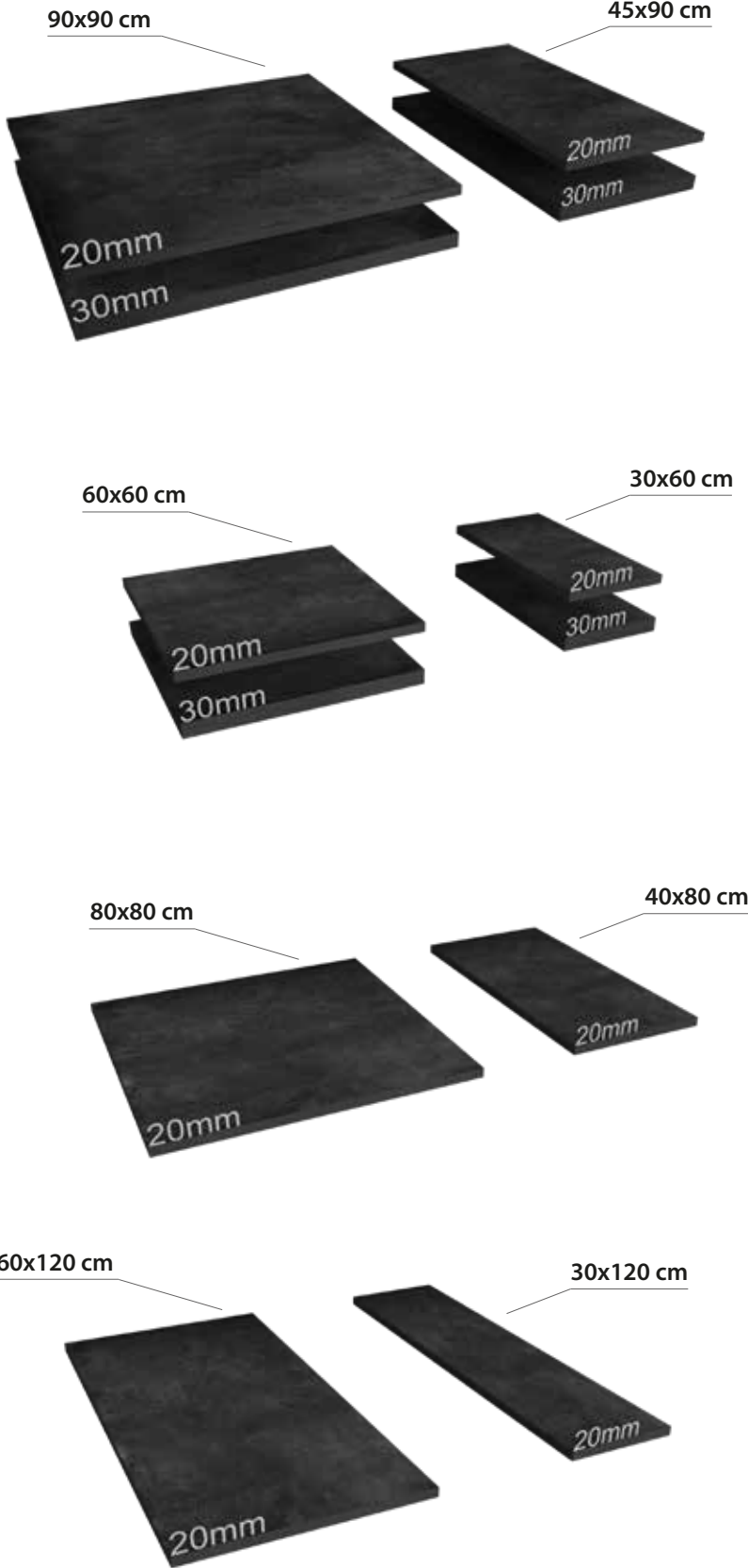

Kalınlık / Thickness: 20 mm

EBAT Sizes	ÜRÜN KODU Product Code	FIYAT Price Code	YÜZEY Surfaces
30x120 cm 12"x48"	312027168	F106	R9 FLAT
	312067468	F107	R11 FLAT
	312068568	F107	R13 RELIEF
30x60 cm 12"x24"	112027168	F108	R9 FLAT
	112067468	F109	R11 FLAT
	112068568	F109	R13 RELIEF
40x80 cm 16"x32"	712027168	F110	R9 FLAT
	712067468	F111	R11 FLAT
45x90 cm 18"x36"	812027168	F112	R9 FLAT
	812067468	F113	R11 FLAT
60x120 cm 24"x48"	302027168	F101	R9 FLAT
	302067468	F103	R11 FLAT
	302068568	F103	R13 RELIEF
60x60 cm 24"x24"	102027168	F100	R9 FLAT
	102067468	F102	R11 FLAT
	102068568	F102	R13 RELIEF
80x80 cm 32"x32"	702027168	F104	R9 FLAT
	702067468	F105	R11 FLAT
90x90 cm 36"x36"	802027168	F114	R9 FLAT
	802067468	F115	R11 FLAT

Kalınlık / Thickness: 30 mm

EBAT Sizes	ÜRÜN KODU Product Code	FIYAT Price Code	YÜZEY Surfaces
30x60 cm 12"x24"	113027168	F118	R9 FLAT
	113067468	F119	R11 FLAT
45x90 cm 18"x36"	813027168	F122	R9 FLAT
	813067468	F123	R11 FLAT
60x60 cm 24"x24"	103027168	F116	R9 FLAT
	103067468	F117	R11 FLAT
90x90 cm 36"x36"	803027168	F120	R9 FLAT
	803067468	F121	R11 FLAT

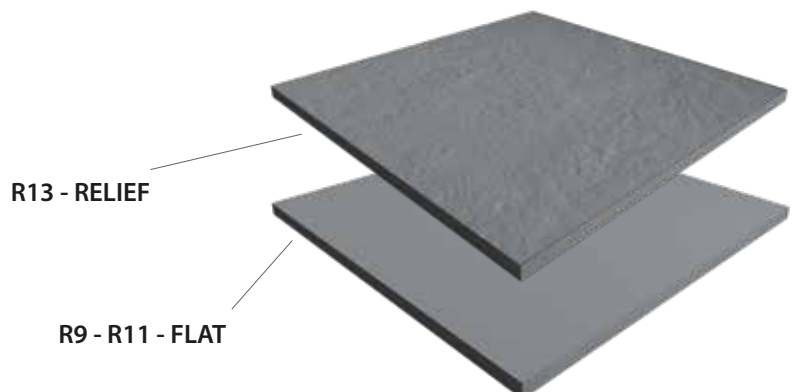

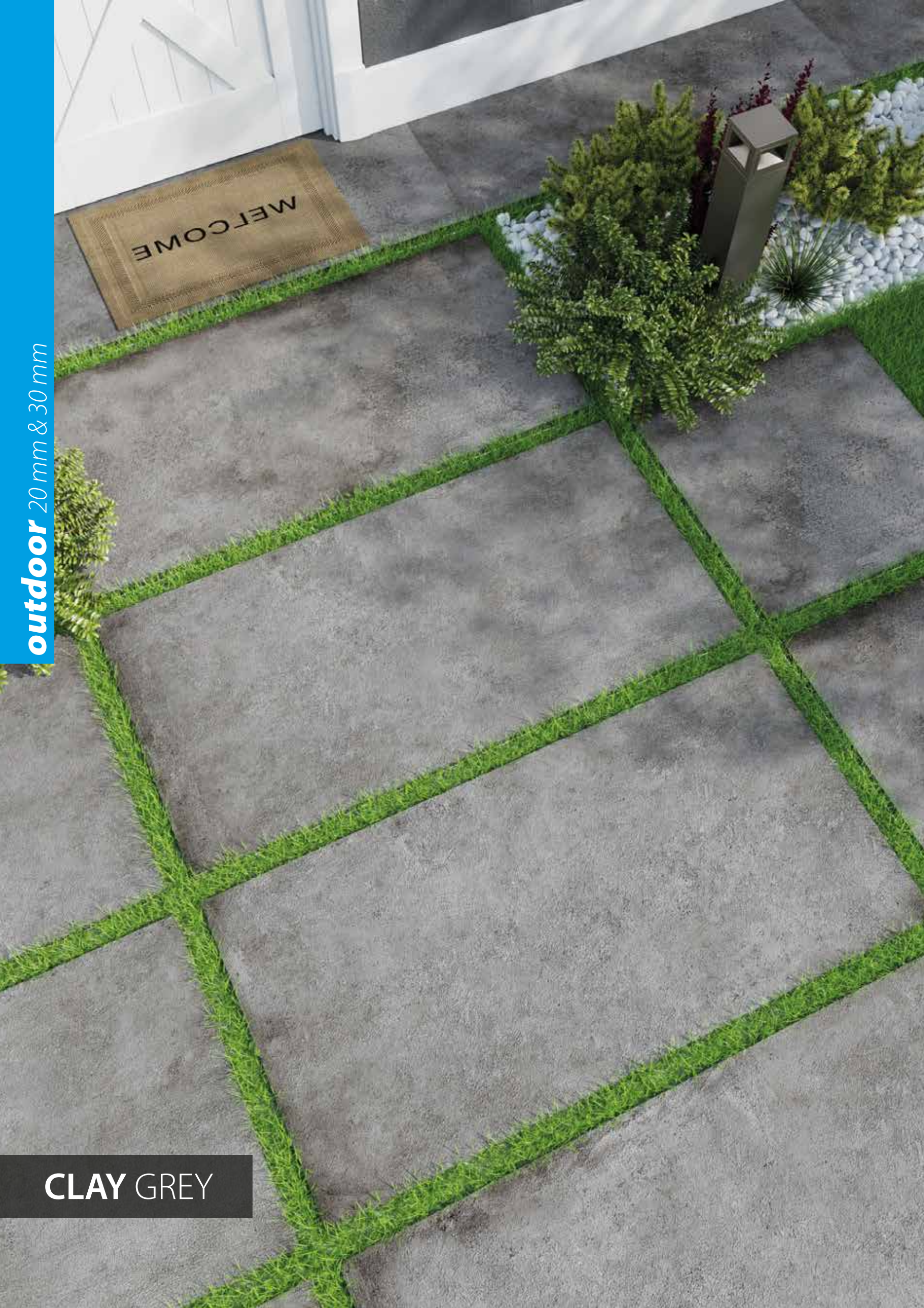

outdoor 20 mm & 30 mm

CLAY GREY

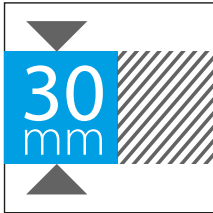



outdoor 20 mm & 30 mm

CLAY GREY

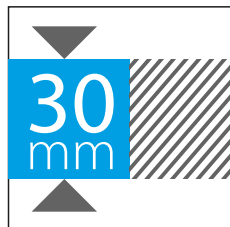
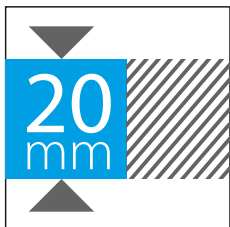
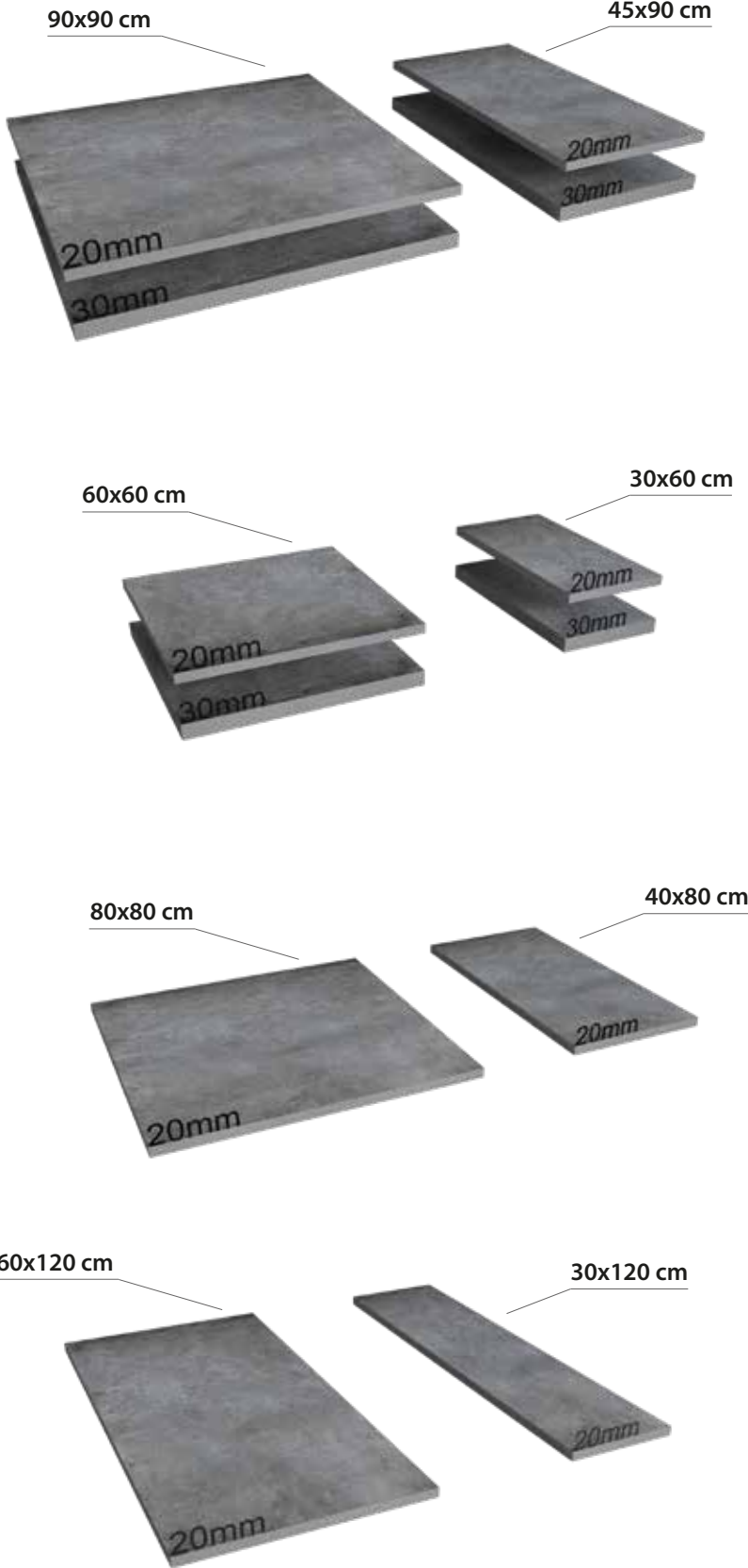

Kalınlık / Thickness: 20 mm

EBAT Sizes	ÜRÜN KODU Product Code	FIYAT Price Code	YÜZEY Surfaces
30x120 cm 12"x48"	312027109	F106	R9 FLAT
	312067409	F107	R11 FLAT
	312068509	F107	R13 RELIEF
30x60 cm 12"x24"	112027109	F108	R9 FLAT
	112067409	F109	R11 FLAT
	112068509	F109	R13 RELIEF
40x80 cm 16"x32"	712027109	F110	R9 FLAT
	712067409	F111	R11 FLAT
45x90 cm 18"x36"	812027109	F112	R9 FLAT
	812067409	F113	R11 FLAT
60x120 cm 24"x48"	302027109	F101	R9 FLAT
	302067409	F103	R11 FLAT
	302068509	F103	R13 RELIEF
60x60 cm 24"x24"	102027109	F100	R9 FLAT
	102067409	F102	R11 FLAT
	102068509	F102	R13 RELIEF
80x80 cm 32"x32"	702027109	F104	R9 FLAT
	702067409	F105	R11 FLAT
90x90 cm 36"x36"	802027109	F114	R9 FLAT
	802067409	F115	R11 FLAT

Kalınlık / Thickness: 30 mm

EBAT Sizes	ÜRÜN KODU Product Code	FIYAT Price Code	YÜZEY Surfaces
30x60 cm 12"x24"	113027109	F118	R9 FLAT
	113067409	F119	R11 FLAT
45x90 cm 18"x36"	813027109	F122	R9 FLAT
	813067409	F123	R11 FLAT
60x60 cm 24"x24"	103027109	F116	R9 FLAT
	103067409	F117	R11 FLAT
90x90 cm 36"x36"	803027109	F120	R9 FLAT
	803067409	F121	R11 FLAT

R13 - RELIEF

R9 - R11 - FLAT

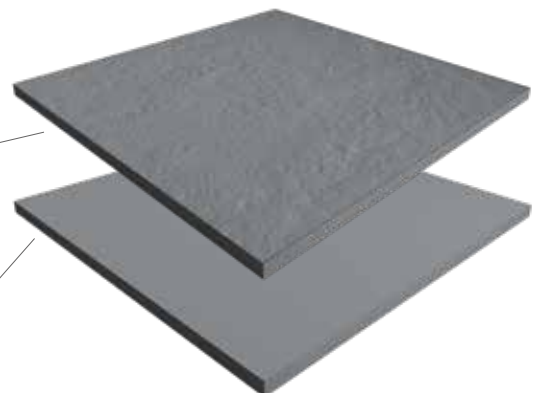

outdoor 20 mm & 30 mm



CLAY SAND

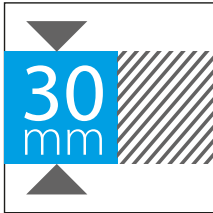

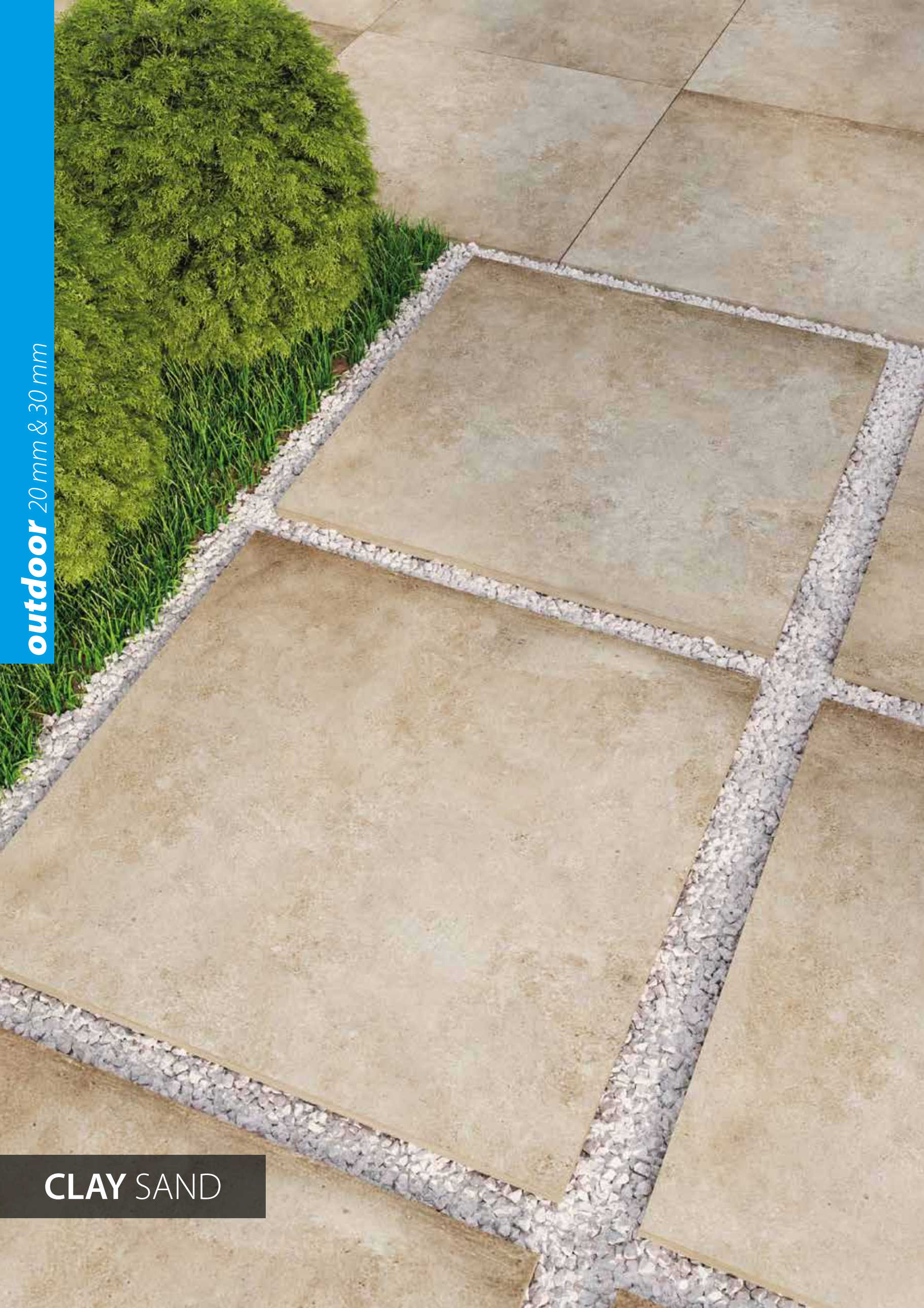

outdoor 20 mm & 30 mm

CLAY SAND

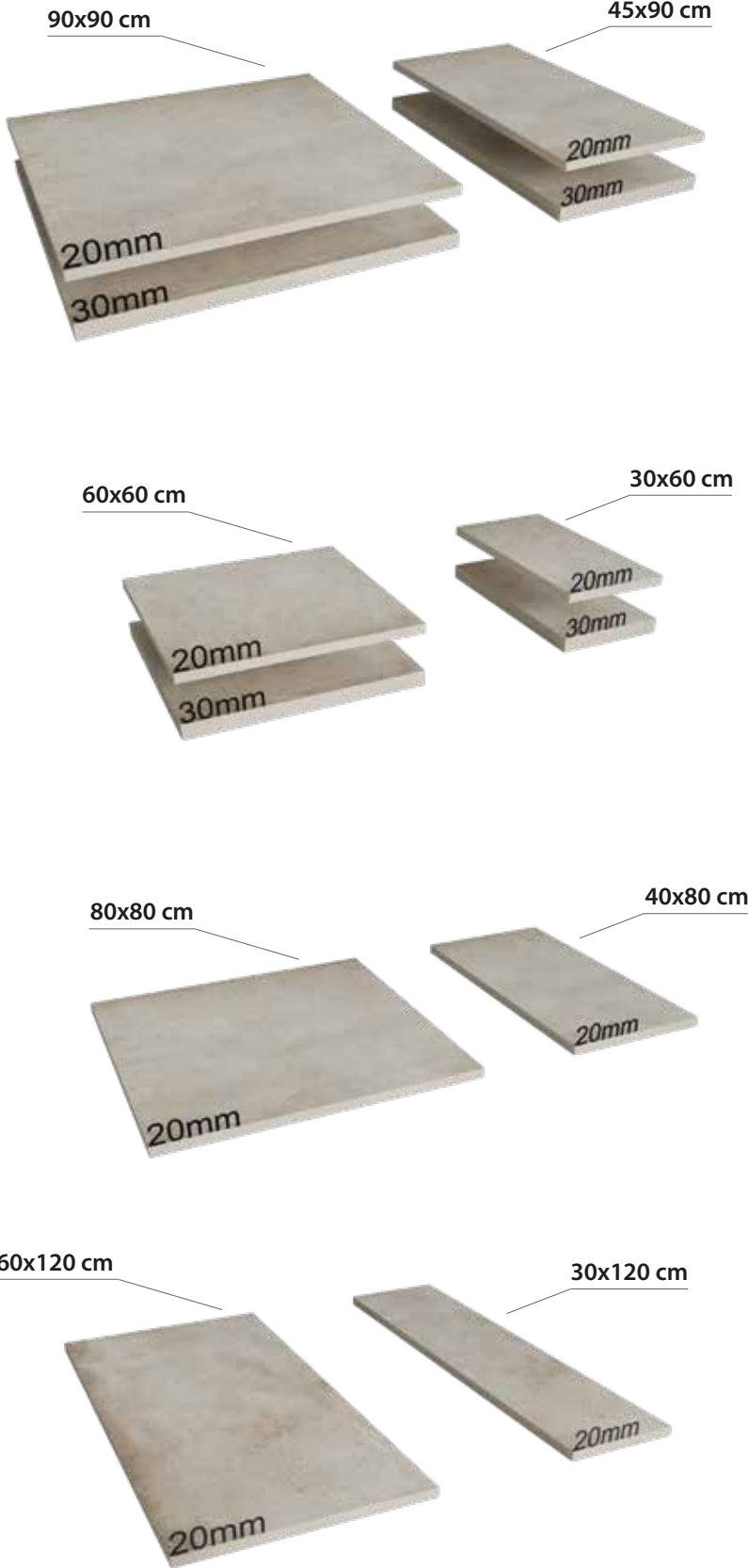

Kalınlık / Thickness: 20 mm

EBAT Sizes	ÜRÜN KODU Product Code	FIYAT Price Code	YÜZEY Surfaces
30x120 cm 12"x48"	312027158	F106	R9 FLAT
	312067458	F107	R11 FLAT
	312068558	F107	R13 RELIEF
30x60 cm 12"x24"	112027158	F108	R9 FLAT
	112067458	F109	R11 FLAT
	112068558	F109	R13 RELIEF
40x80 cm 16"x32"	712027158	F110	R9 FLAT
	712067458	F111	R11 FLAT
45x90 cm 18"x36"	812027158	F112	R9 FLAT
	812067458	F113	R11 FLAT
60x120 cm 24"x48"	302027158	F101	R9 FLAT
	302067458	F103	R11 FLAT
	302068558	F103	R13 RELIEF
60x60 cm 24"x24"	102027158	F100	R9 FLAT
	102067458	F102	R11 FLAT
	102068558	F102	R13 RELIEF
80x80 cm 32"x32"	702027158	F104	R9 FLAT
	702067458	F105	R11 FLAT
90x90 cm 36"x36"	802027158	F114	R9 FLAT
	802067458	F115	R11 FLAT

Kalınlık / Thickness: 30 mm

EBAT Sizes	ÜRÜN KODU Product Code	FIYAT Price Code	YÜZEY Surfaces
30x60 cm 12"x24"	113027158	F118	R9 FLAT
	113067458	F119	R11 FLAT
45x90 cm 18"x36"	813027158	F122	R9 FLAT
	813067458	F123	R11 FLAT
60x60 cm 24"x24"	103027158	F116	R9 FLAT
	103067458	F117	R11 FLAT
90x90 cm 36"x36"	803027158	F120	R9 FLAT
	803067458	F121	R11 FLAT

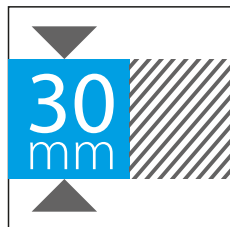
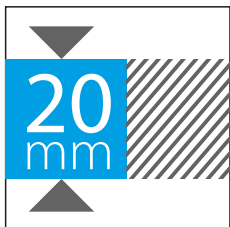

R13 - RELIEF

R9 - R11 - FLAT

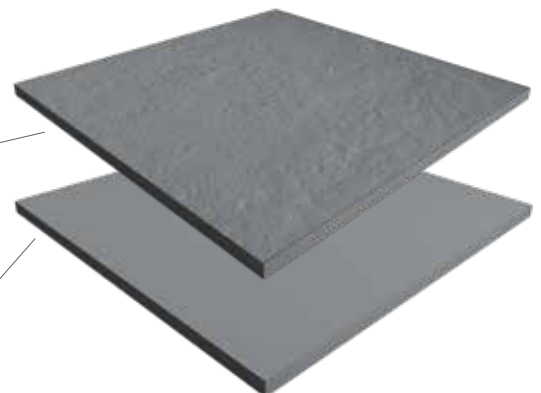



outdoor 20 mm & 30 mm

CLAY WHITE

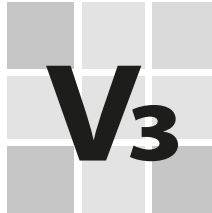
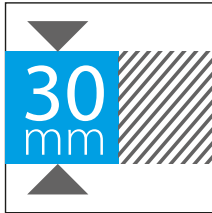
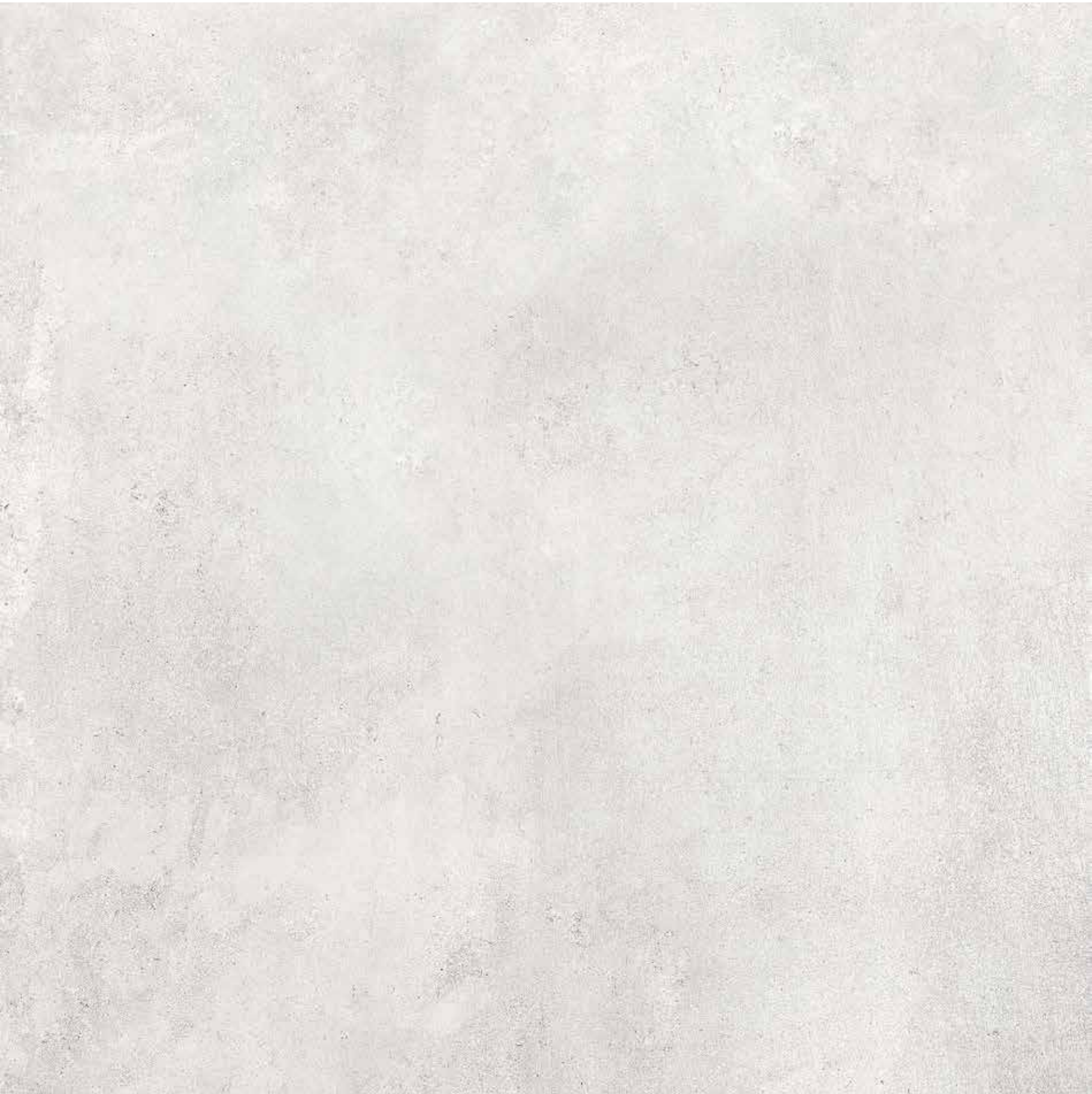

outdoor 20 mm & 30 mm



CLAY WHITE

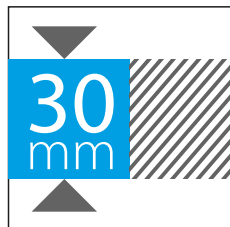
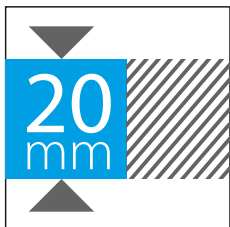
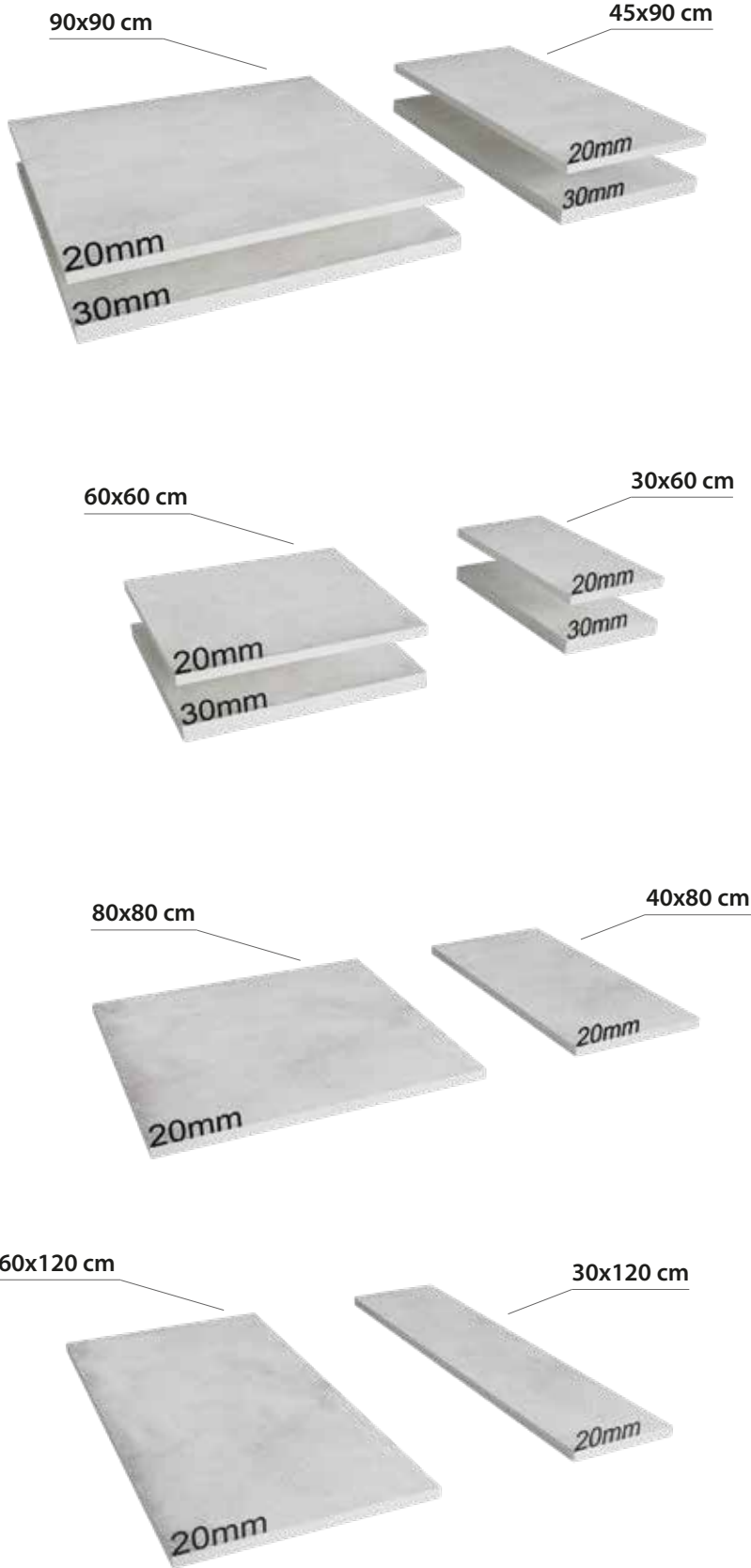

Kalınlık / Thickness: 20 mm

EBAT Sizes	ÜRÜN KODU Product Code	FIYAT Price Code	YÜZEY Surfaces
30x120 cm 12"x48"	312027110	F106	R9 FLAT
	312067410	F107	R11 FLAT
	312068510	F107	R13 RELIEF
30x60 cm 12"x24"	112027110	F108	R9 FLAT
	112067410	F109	R11 FLAT
	112068510	F109	R13 RELIEF
40x80 cm 16"x32"	712027110	F110	R9 FLAT
	712067410	F111	R11 FLAT
45x90 cm 18"x36"	812027110	F112	R9 FLAT
	812067410	F113	R11 FLAT
60x120 cm 24"x48"	302027110	F101	R9 FLAT
	302067410	F103	R11 FLAT
	302068510	F103	R13 RELIEF
60x60 cm 24"x24"	102027110	F100	R9 FLAT
	102067410	F102	R11 FLAT
	102068510	F102	R13 RELIEF
80x80 cm 32"x32"	702027110	F104	R9 FLAT
	702067410	F105	R11 FLAT
90x90 cm 36"x36"	802027110	F114	R9 FLAT
	802067410	F115	R11 FLAT

Kalınlık / Thickness: 30 mm

EBAT Sizes	ÜRÜN KODU Product Code	FIYAT Price Code	YÜZEY Surfaces
30x60 cm 12"x24"	113027110	F118	R9 FLAT
	113067410	F119	R11 FLAT
45x90 cm 18"x36"	813027110	F122	R9 FLAT
	813067410	F123	R11 FLAT
60x60 cm 24"x24"	103027110	F116	R9 FLAT
	103067410	F117	R11 FLAT
90x90 cm 36"x36"	803027110	F120	R9 FLAT
	803067410	F121	R11 FLAT

R13 - RELIEF

R9 - R11 - FLAT

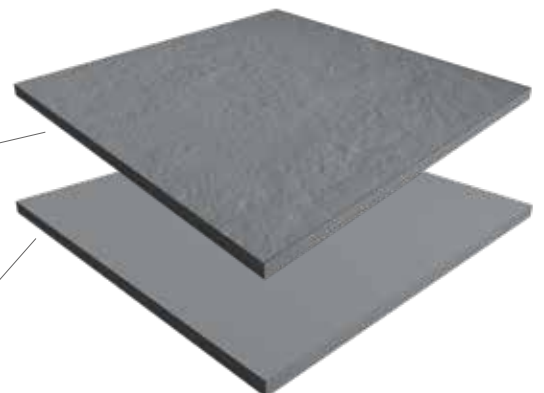

outdoor 20 mm & 30 mm

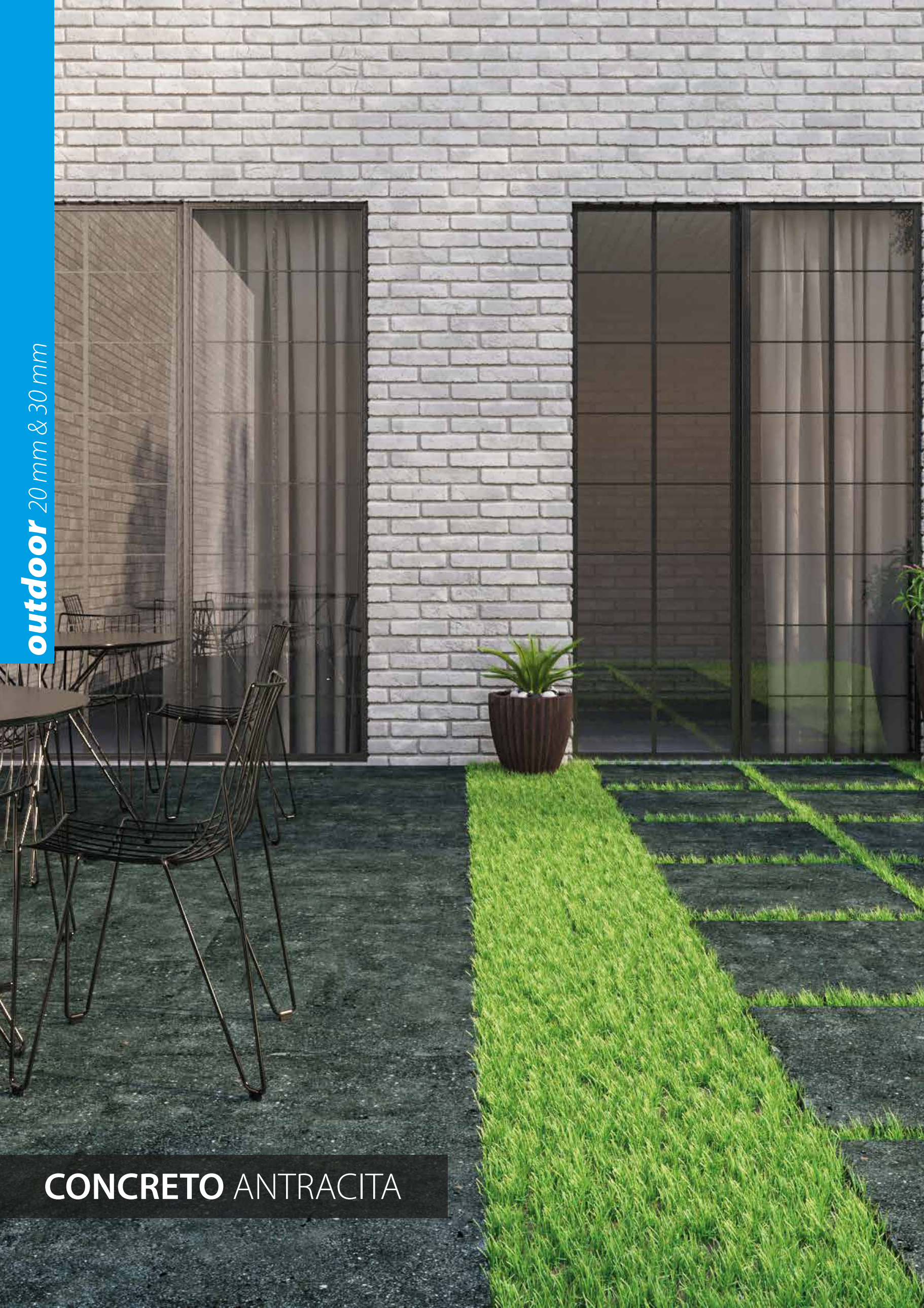

CONCRETO ANTRACITA

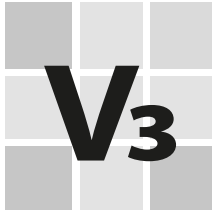
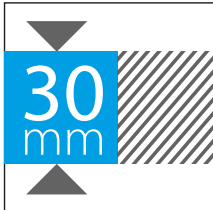
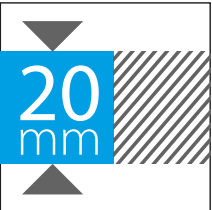
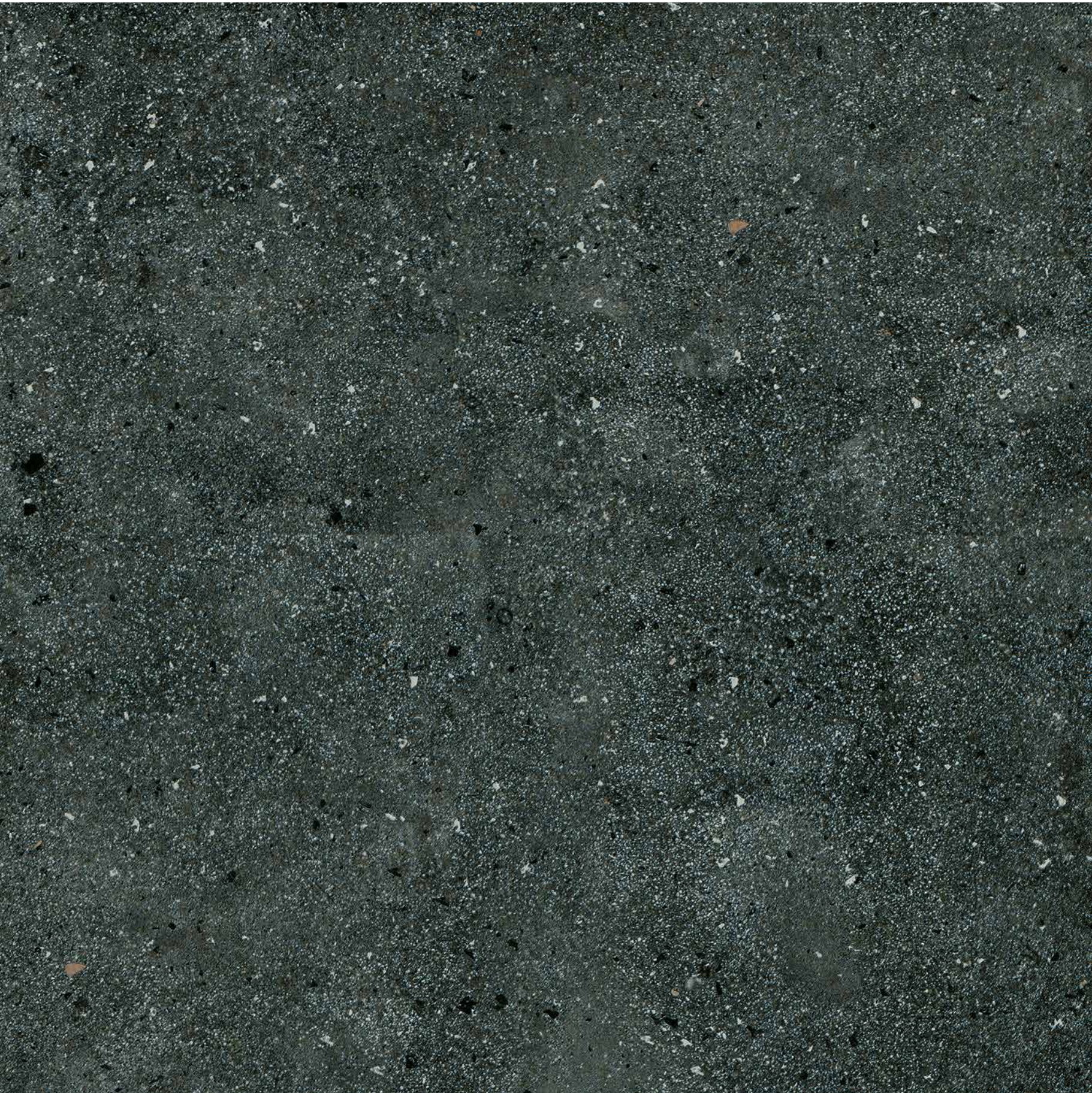

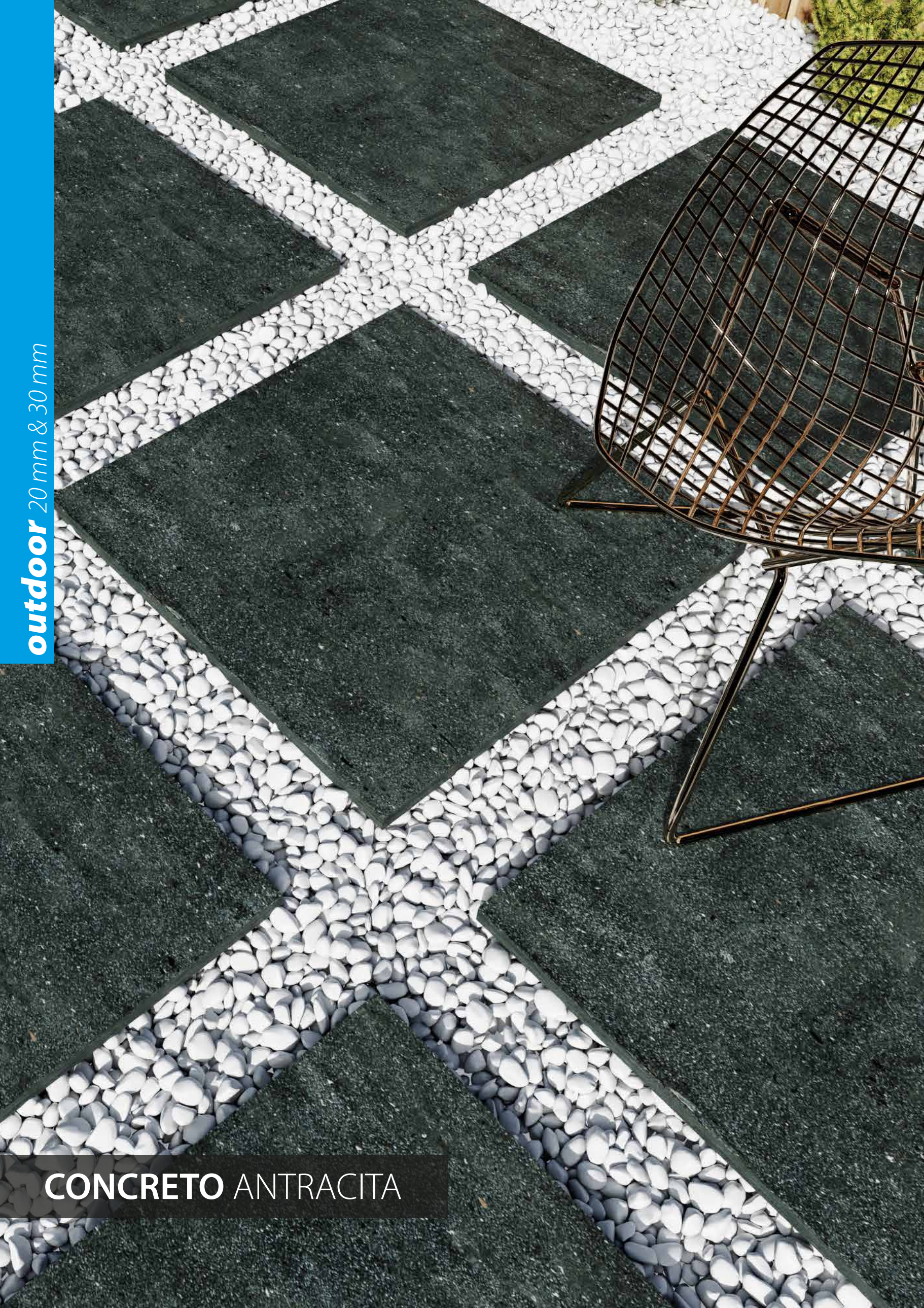

outdoor 20 mm & 30 mm

CONCRETO ANTRACITA

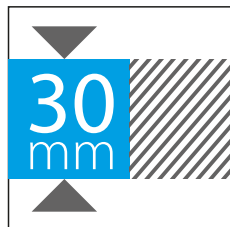
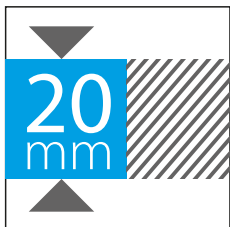
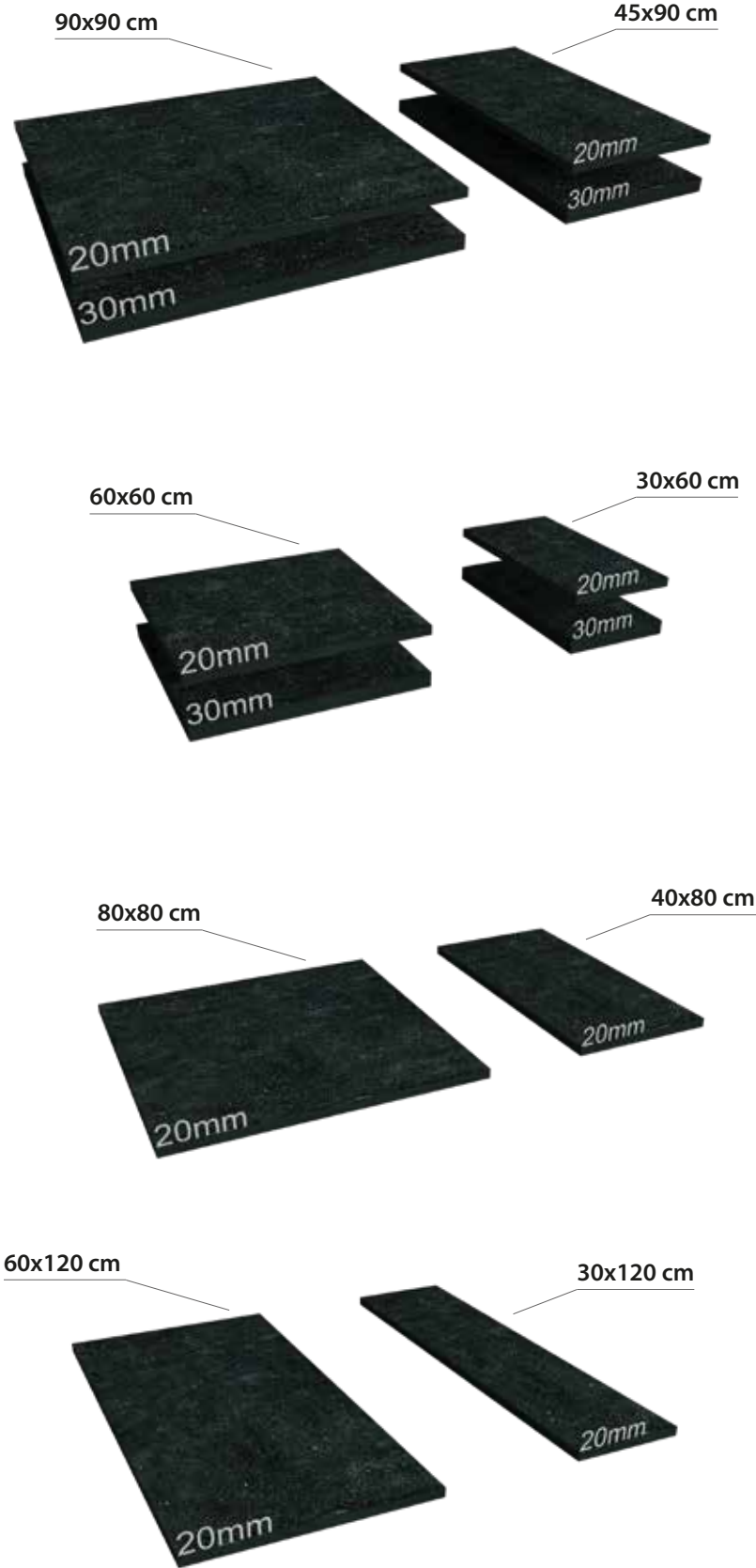

Kalınlık / Thickness: 20 mm

EBAT Sizes	ÜRÜN KODU Product Code	FIYAT Price Code	YÜZEY Surfaces
30x120 cm 12"x48"	312060368	F106	R9 FLAT
	312067568	F107	R11 FLAT
	312068768	F107	R13 RELIEF
30x60 cm 12"x24"	112060368	F108	R9 FLAT
	112067568	F109	R11 FLAT
	112068768	F109	R13 RELIEF
40x80 cm 16"x32"	712060368	F110	R9 FLAT
	712067568	F111	R11 FLAT
45x90 cm 18"x36"	812060368	F112	R9 FLAT
	812067568	F113	R11 FLAT
60x120 cm 24"x48"	302060368	F101	R9 FLAT
	302067568	F103	R11 FLAT
	302068768	F103	R13 RELIEF
60x60 cm 24"x24"	102060368	F100	R9 FLAT
	102067568	F102	R11 FLAT
	102068768	F102	R13 RELIEF
80x80 cm 32"x32"	702060368	F104	R9 FLAT
	702067568	F105	R11 FLAT
90x90 cm 36"x36"	802060368	F114	R9 FLAT
	802067568	F115	R11 FLAT

Kalınlık / Thickness: 30 mm

EBAT Sizes	ÜRÜN KODU Product Code	FIYAT Price Code	YÜZEY Surfaces
30x60 cm 12"x24"	113060368	F118	R9 FLAT
	113067568	F119	R11 FLAT
45x90 cm 18"x36"	813060368	F122	R9 FLAT
	813067568	F123	R11 FLAT
60x60 cm 24"x24"	103060368	F116	R9 FLAT
	103067568	F117	R11 FLAT
90x90 cm 36"x36"	803060368	F120	R9 FLAT
	803067568	F121	R11 FLAT

R13 - RELIEF

R9 - R11 - FLAT

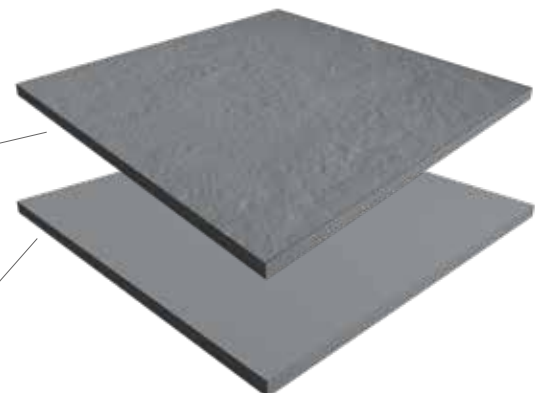



outdoor 20 mm & 30 mm

CONCRETO GREY

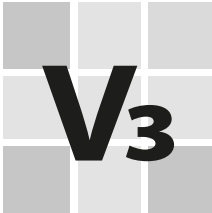
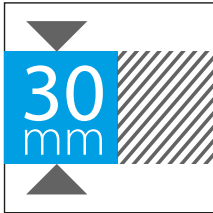

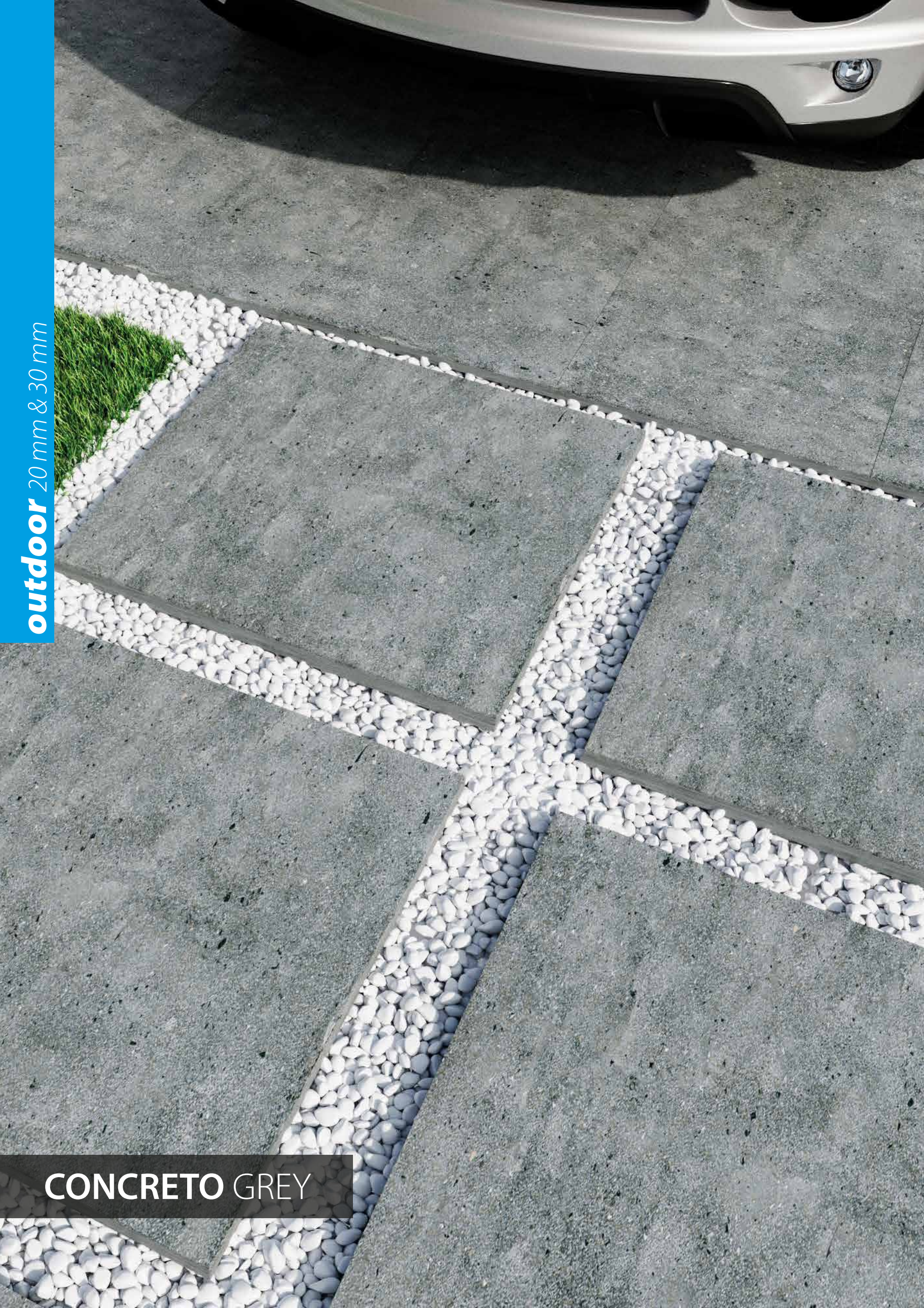

outdoor 20 mm & 30 mm

CONCRETO GREY

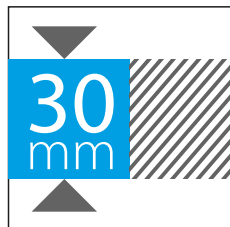
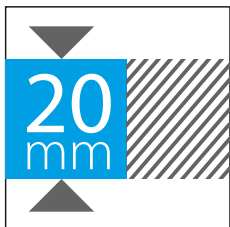
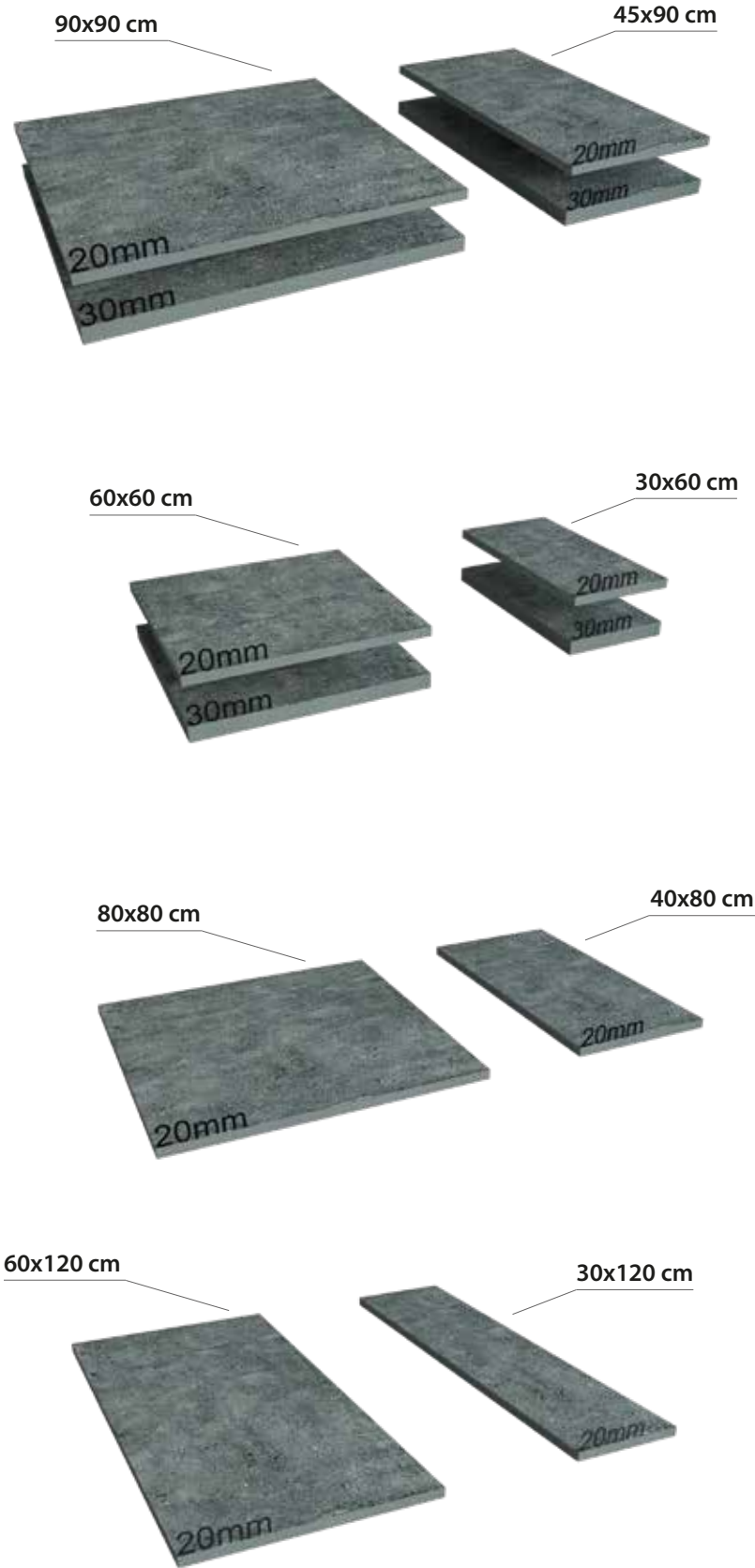

Kalınlık / Thickness: 20 mm

EBAT Sizes	ÜRÜN KODU Product Code	FIYAT Price Code	YÜZEY Surfaces
30x120 cm 12"x48"	312060309	F106	R9 FLAT
	312067509	F107	R11 FLAT
	312068709	F107	R13 RELIEF
30x60 cm 12"x24"	112060309	F108	R9 FLAT
	112067509	F109	R11 FLAT
	112068709	F109	R13 RELIEF
40x80 cm 16"x32"	712060309	F110	R9 FLAT
	712067509	F111	R11 FLAT
45x90 cm 18"x36"	812060309	F112	R9 FLAT
	812067509	F113	R11 FLAT
60x120 cm 24"x48"	302060309	F101	R9 FLAT
	302067509	F103	R11 FLAT
	302068709	F103	R13 RELIEF
60x60 cm 24"x24"	102060309	F100	R9 FLAT
	102067509	F102	R11 FLAT
	102068709	F102	R13 RELIEF
80x80 cm 32"x32"	702060309	F104	R9 FLAT
	702067509	F105	R11 FLAT
90x90 cm 36"x36"	802060309	F114	R9 FLAT
	802067509	F115	R11 FLAT

Kalınlık / Thickness: 30 mm

EBAT Sizes	ÜRÜN KODU Product Code	FIYAT Price Code	YÜZEY Surfaces
30x60 cm 12"x24"	113060309	F118	R9 FLAT
	113067509	F119	R11 FLAT
45x90 cm 18"x36"	813060309	F122	R9 FLAT
	813067509	F123	R11 FLAT
60x60 cm 24"x24"	103060309	F116	R9 FLAT
	103067509	F117	R11 FLAT
90x90 cm 36"x36"	803060309	F120	R9 FLAT
	803067509	F121	R11 FLAT

R13 - RELIEF

R9 - R11 - FLAT

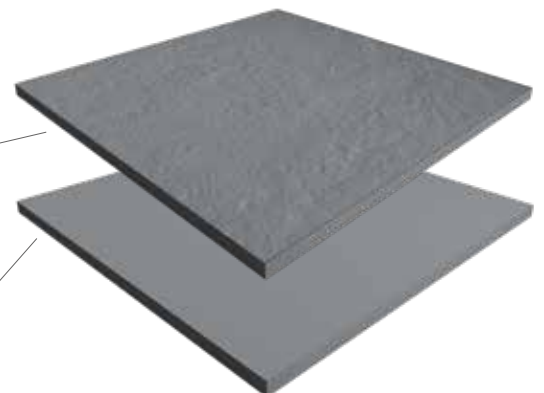

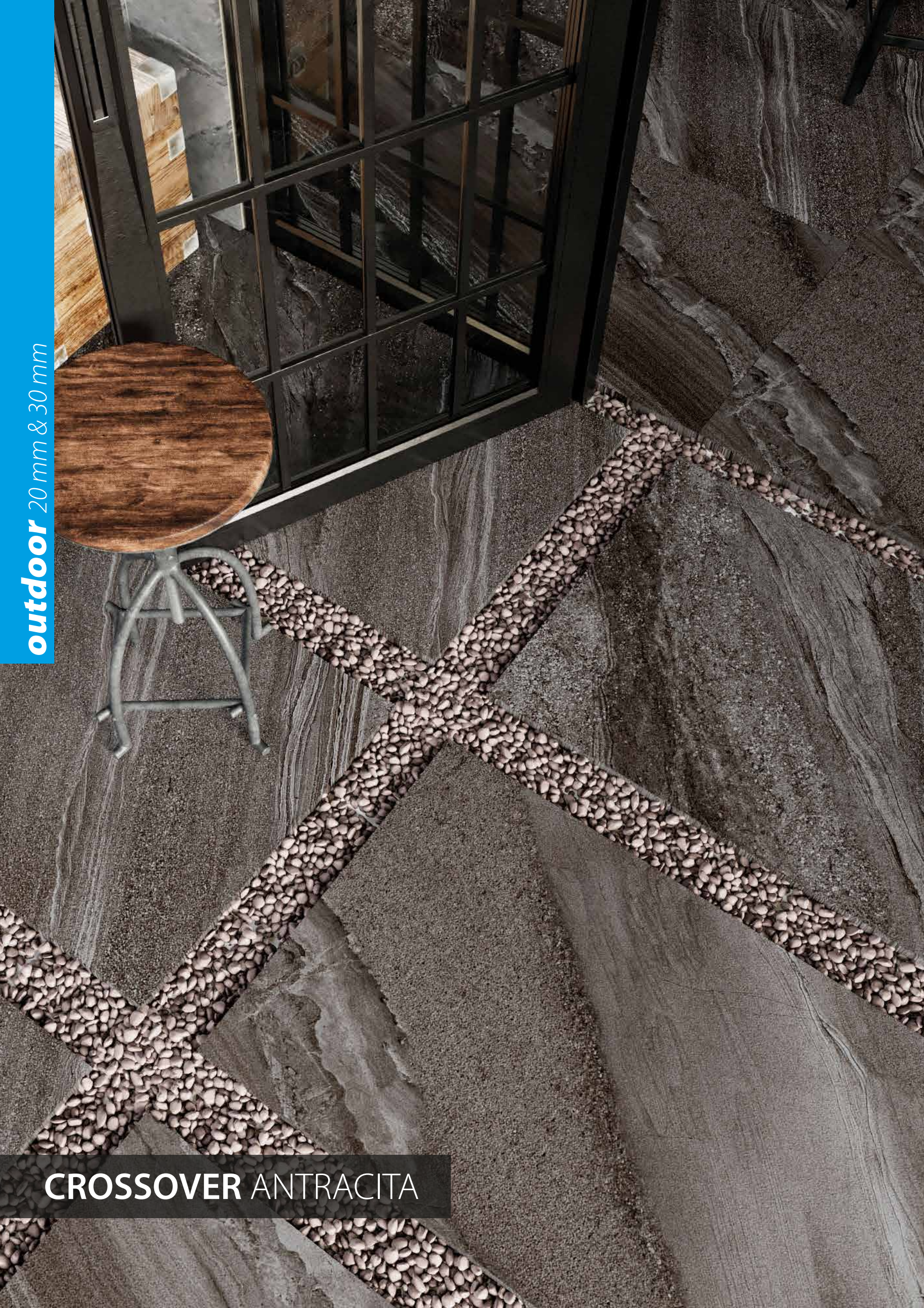

outdoor 20 mm & 30 mm

CROSSOVER ANTRACITA

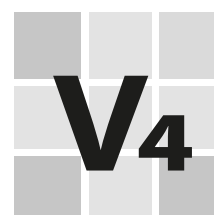
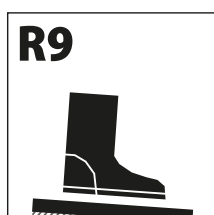
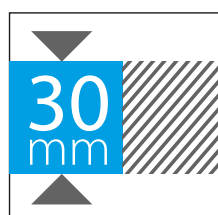
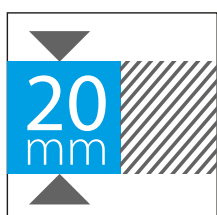
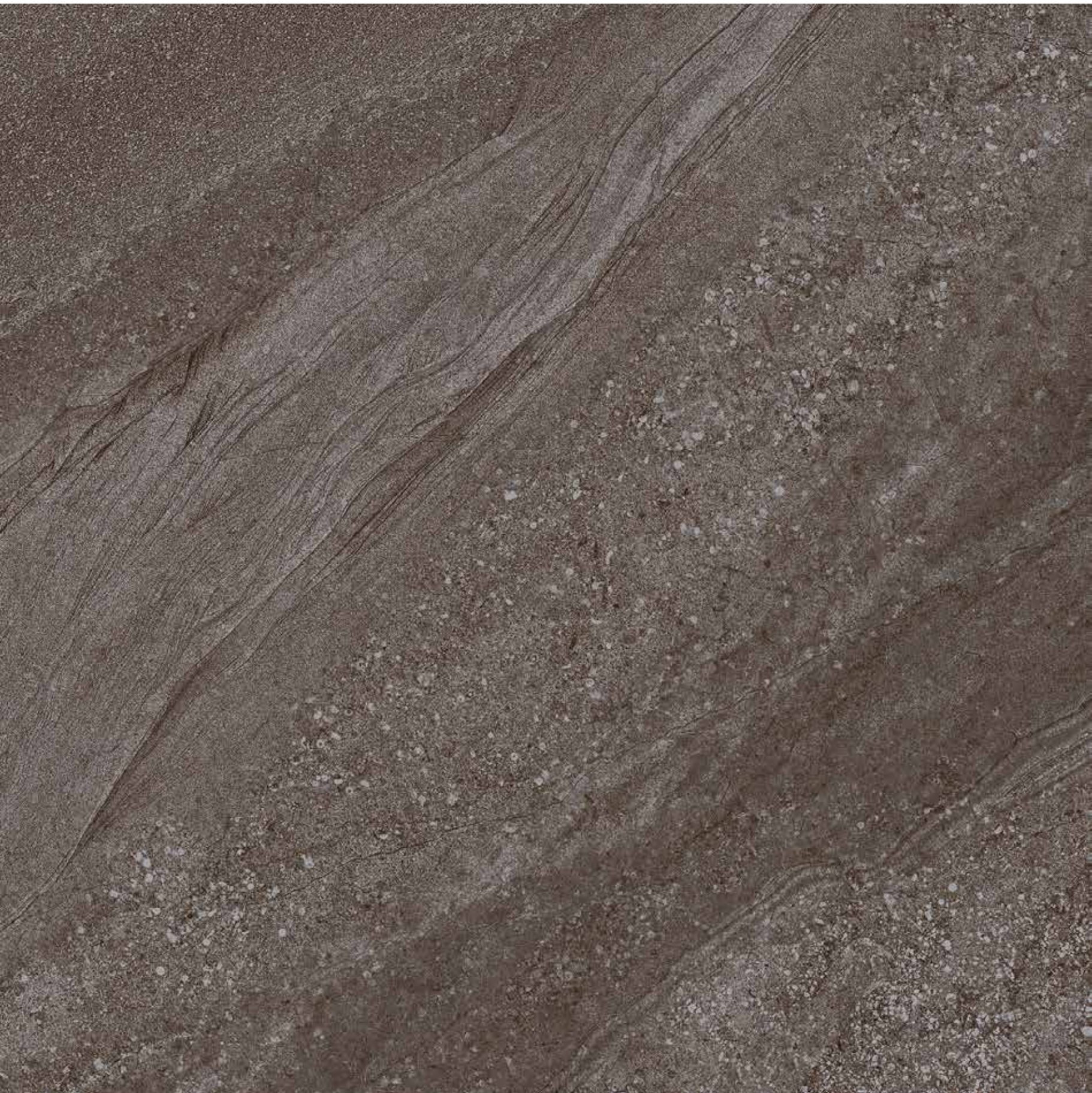



outdoor 20 mm & 30 mm

CROSSOVER ANTRACITA

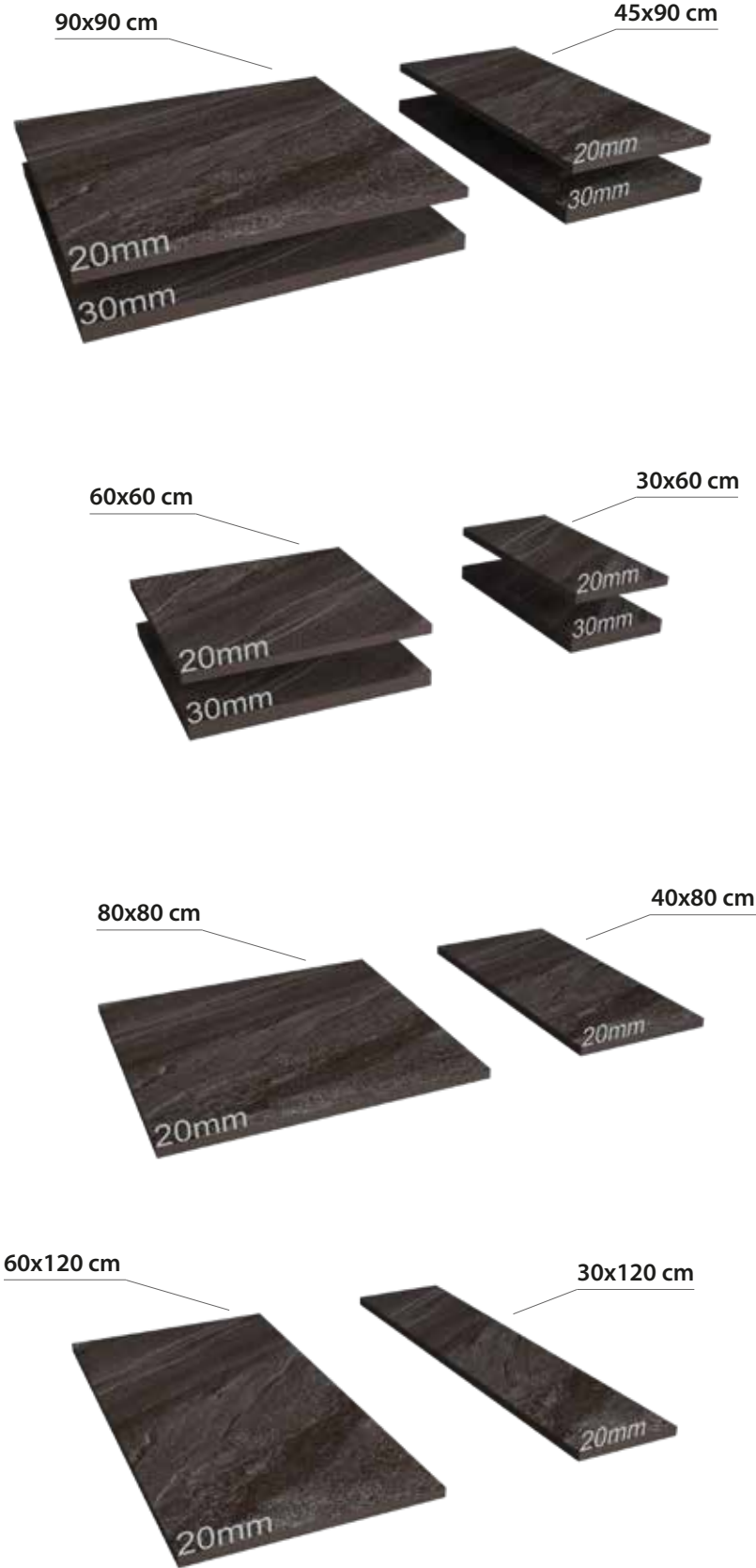

Kalınlık / Thickness: 20 mm

EBAT Sizes	ÜRÜN KODU Product Code	FIYAT Price Code	YÜZEY Surfaces
30x120 cm 12"x48"	312027968	F106	R9 FLAT
	312067768	F107	R11 FLAT
	312069068	F107	R13 RELIEF
30x60 cm 12"x24"	112027968	F108	R9 FLAT
	112067768	F109	R11 FLAT
	112069068	F109	R13 RELIEF
40x80 cm 16"x32"	712027968	F110	R9 FLAT
	712067768	F111	R11 FLAT
45x90 cm 18"x36"	812027968	F112	R9 FLAT
	812067768	F113	R11 FLAT
60x120 cm 24"x48"	302027968	F101	R9 FLAT
	302067768	F103	R11 FLAT
	302069068	F103	R13 RELIEF
60x60 cm 24"x24"	102027968	F100	R9 FLAT
	102067768	F102	R11 FLAT
	102069068	F102	R13 RELIEF
80x80 cm 32"x32"	702027968	F104	R9 FLAT
	702067768	F105	R11 FLAT
90x90 cm 36"x36"	802027968	F114	R9 FLAT
	802067768	F115	R11 FLAT

Kalınlık / Thickness: 30 mm

EBAT Sizes	ÜRÜN KODU Product Code	FIYAT Price Code	YÜZEY Surfaces
30x60 cm 12"x24"	113027968	F118	R9 FLAT
	113067768	F119	R11 FLAT
45x90 cm 18"x36"	813027968	F122	R9 FLAT
	813067768	F123	R11 FLAT
60x60 cm 24"x24"	103027968	F116	R9 FLAT
	103067768	F117	R11 FLAT
90x90 cm 36"x36"	803027968	F120	R9 FLAT
	803067768	F121	R11 FLAT

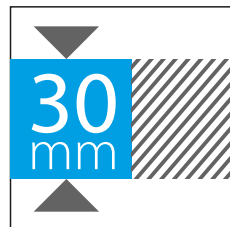
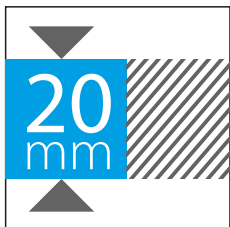

R13 - RELIEF

R9 - R11 - FLAT

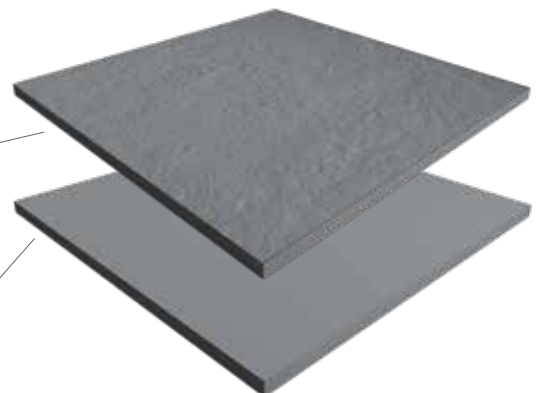

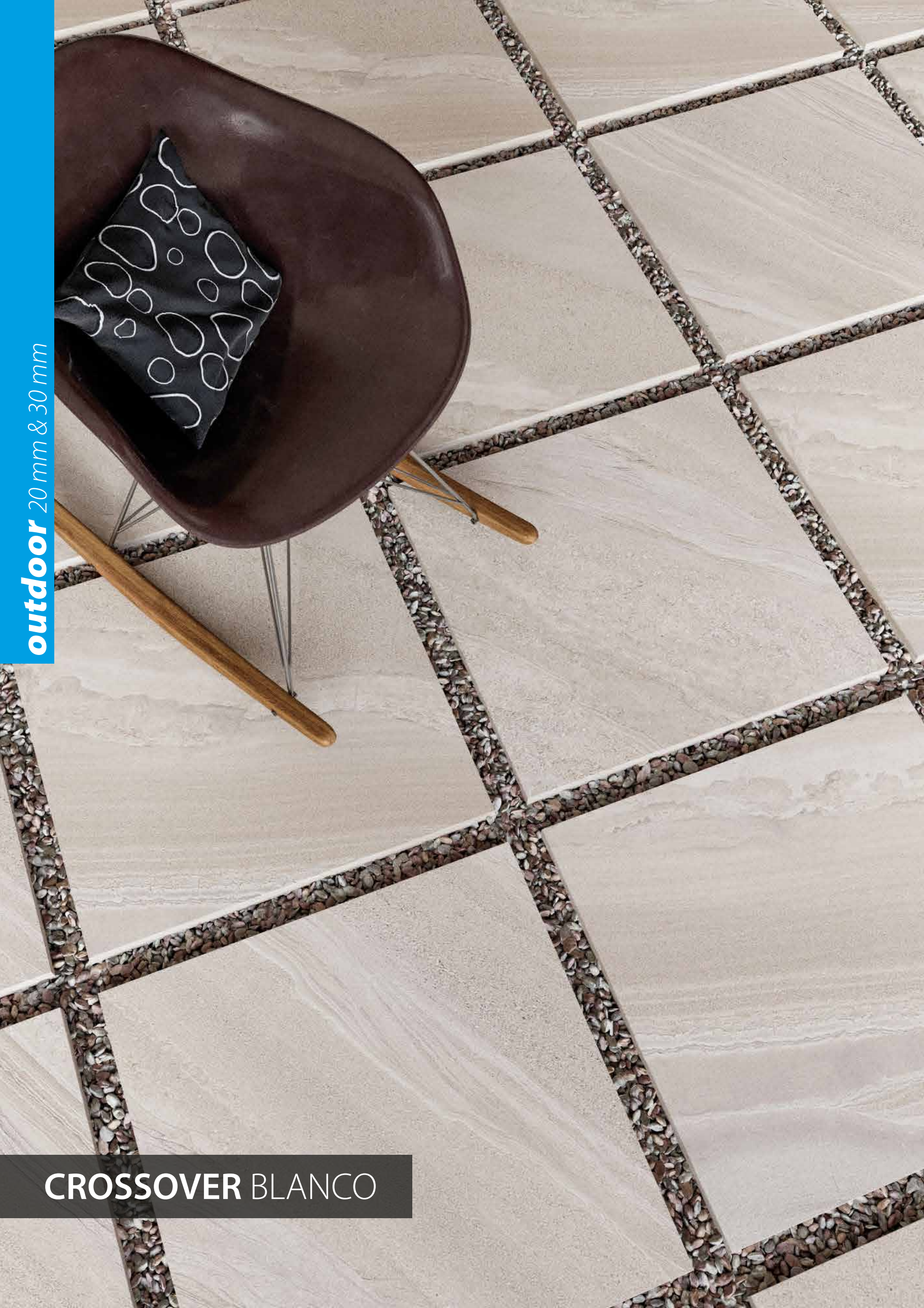

outdoor 20 mm & 30 mm

CROSSOVER BLANCO

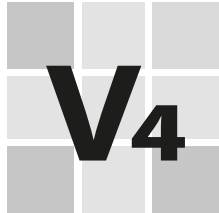
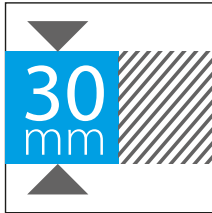

outdoor 20 mm & 30 mm

CROSSOVER BLANCO



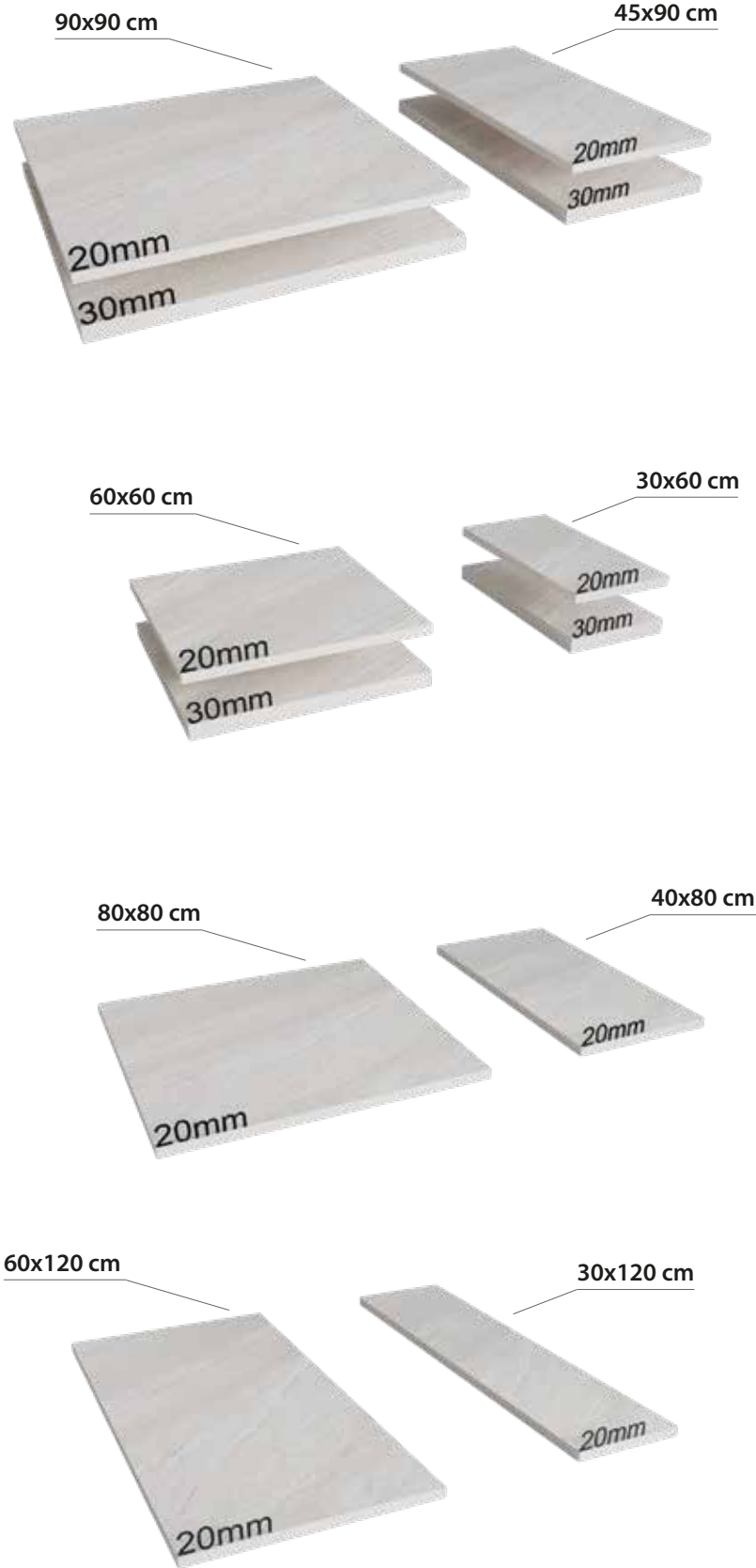

Kalınlık / Thickness: 20 mm

EBAT Sizes	ÜRÜN KODU Product Code	FIYAT Price Code	YÜZEY Surfaces
30x120 cm 12"x48"	312027959	F106	R9 FLAT
	312067759	F107	R11 FLAT
	312069059	F107	R13 RELIEF
30x60 cm 12"x24"	112027959	F108	R9 FLAT
	112067759	F109	R11 FLAT
	112069059	F109	R13 RELIEF
40x80 cm 16"x32"	712027959	F110	R9 FLAT
	712067759	F111	R11 FLAT
45x90 cm 18"x36"	812027959	F112	R9 FLAT
	812067759	F113	R11 FLAT
60x120 cm 24"x48"	302027959	F101	R9 FLAT
	302067759	F103	R11 FLAT
	302069059	F103	R13 RELIEF
60x60 cm 24"x24"	102027959	F100	R9 FLAT
	102067759	F102	R11 FLAT
	102069059	F102	R13 RELIEF
80x80 cm 32"x32"	702027959	F104	R9 FLAT
	702067759	F105	R11 FLAT
90x90 cm 36"x36"	802027959	F114	R9 FLAT
	802067759	F115	R11 FLAT

Kalınlık / Thickness: 30 mm

EBAT Sizes	ÜRÜN KODU Product Code	FIYAT Price Code	YÜZEY Surfaces
30x60 cm 12"x24"	113027959	F118	R9 FLAT
	113067759	F119	R11 FLAT
45x90 cm 18"x36"	813027959	F122	R9 FLAT
	813067759	F123	R11 FLAT
60x60 cm 24"x24"	103027959	F116	R9 FLAT
	103067759	F117	R11 FLAT
90x90 cm 36"x36"	803027959	F120	R9 FLAT
	803067759	F121	R11 FLAT

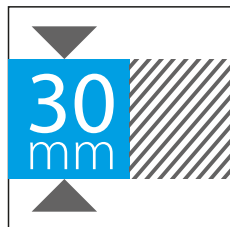
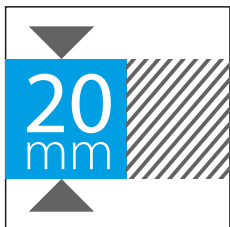

R13 - RELIEF

R9 - R11 - FLAT

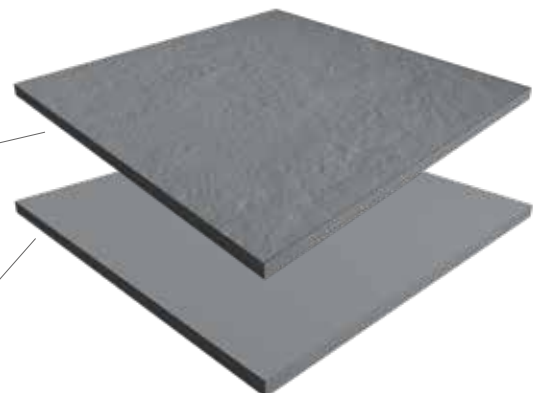

outdoor 20 mm & 30 mm



CROSSOVER GREY

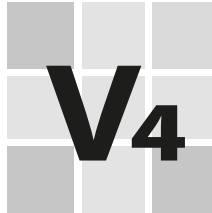
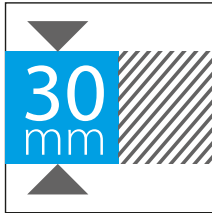

outdoor 20 mm & 30 mm



CROSSOVER GREY

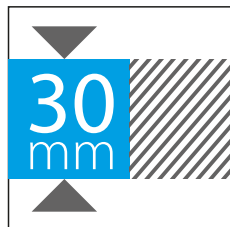
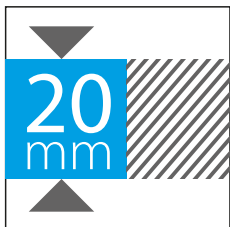
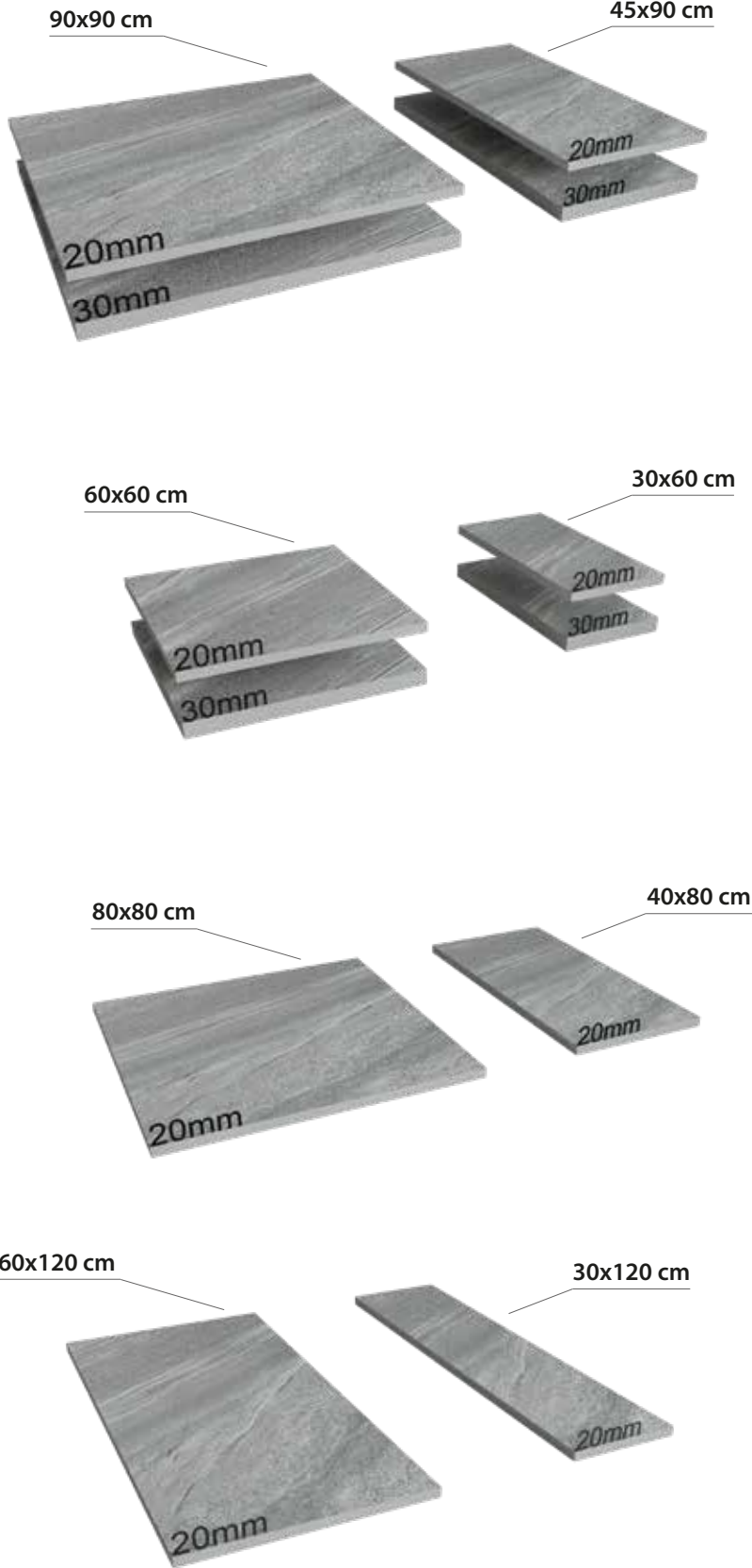

Kalınlık / Thickness: 20 mm

EBAT Sizes	ÜRÜN KODU Product Code	FIYAT Price Code	YÜZEY Surfaces
30x120 cm 12"x48"	312027909	F106	R9 FLAT
	312067709	F107	R11 FLAT
	312069009	F107	R13 RELIEF
30x60 cm 12"x24"	112027909	F108	R9 FLAT
	112067709	F109	R11 FLAT
	112069009	F109	R13 RELIEF
40x80 cm 16"x32"	712027909	F110	R9 FLAT
	712067709	F111	R11 FLAT
45x90 cm 18"x36"	812027909	F112	R9 FLAT
	812067709	F113	R11 FLAT
60x120 cm 24"x48"	302027909	F101	R9 FLAT
	302067709	F103	R11 FLAT
	302069009	F103	R13 RELIEF
60x60 cm 24"x24"	102027909	F100	R9 FLAT
	102067709	F102	R11 FLAT
	102069009	F102	R13 RELIEF
80x80 cm 32"x32"	702027909	F104	R9 FLAT
	702067709	F105	R11 FLAT
90x90 cm 36"x36"	802027909	F114	R9 FLAT
	802067709	F115	R11 FLAT

Kalınlık / Thickness: 30 mm

EBAT Sizes	ÜRÜN KODU Product Code	FIYAT Price Code	YÜZEY Surfaces
30x60 cm 12"x24"	113027909	F118	R9 FLAT
	113067709	F119	R11 FLAT
45x90 cm 18"x36"	813027909	F122	R9 FLAT
	813067709	F123	R11 FLAT
60x60 cm 24"x24"	103027909	F116	R9 FLAT
	103067709	F117	R11 FLAT
90x90 cm 36"x36"	803027909	F120	R9 FLAT
	803067709	F121	R11 FLAT

R13 - RELIEF

R9 - R11 - FLAT

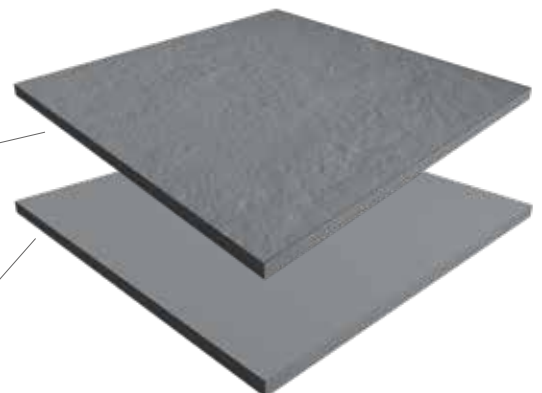



outdoor 20 mm & 30 mm

EARTH ANTRACITA

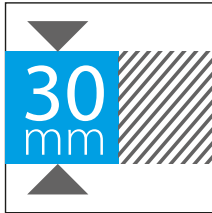

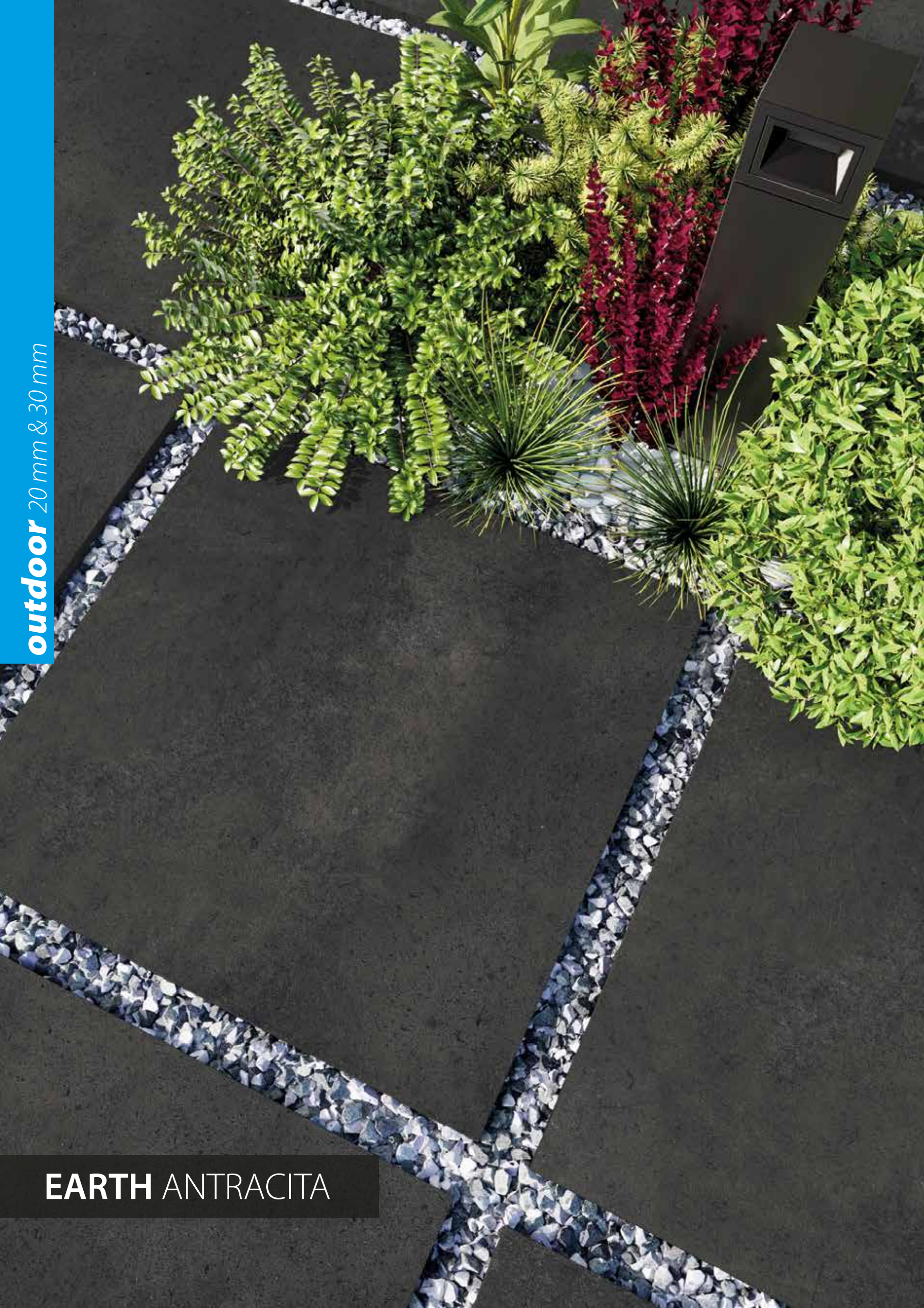

outdoor 20 mm & 30 mm

EARTH ANTRACITA

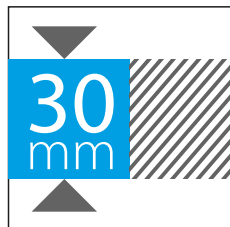
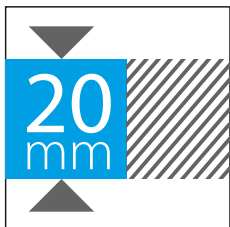
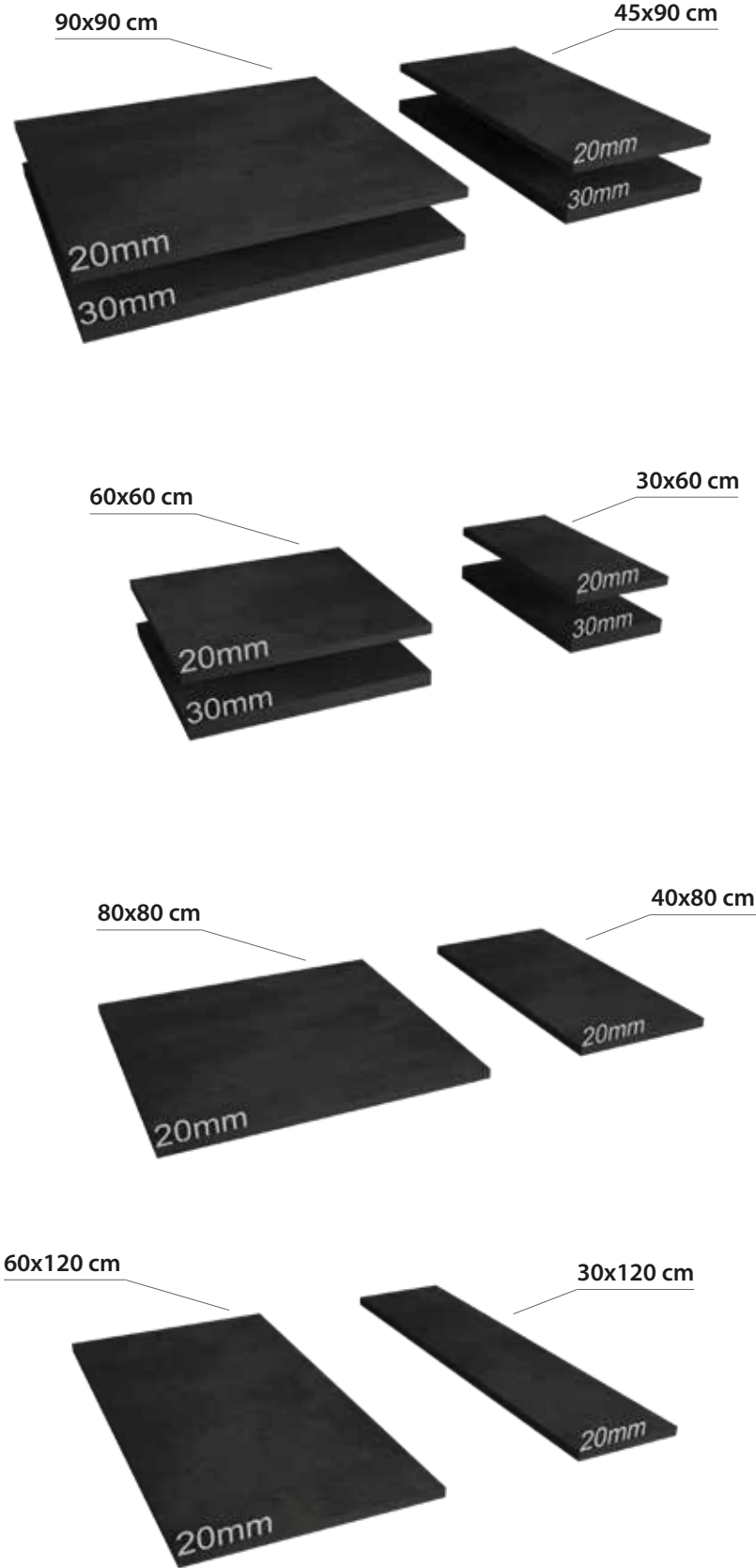

Kalınlık / Thickness: 20 mm

EBAT Sizes	ÜRÜN KODU Product Code	FIYAT Price Code	YÜZEY Surfaces
30x120 cm 12"x48"	312028568	F106	R9 FLAT
	312068368	F107	R11 FLAT
	312068668	F107	R13 RELIEF
30x60 cm 12"x24"	112028568	F108	R9 FLAT
	112068368	F109	R11 FLAT
	112068668	F109	R13 RELIEF
40x80 cm 16"x32"	712028568	F110	R9 FLAT
	712068368	F111	R11 FLAT
45x90 cm 18"x36"	812028568	F112	R9 FLAT
	812068368	F113	R11 FLAT
60x120 cm 24"x48"	302028568	F101	R9 FLAT
	302068368	F103	R11 FLAT
	302068668	F103	R13 RELIEF
60x60 cm 24"x24"	102028568	F100	R9 FLAT
	102068368	F102	R11 FLAT
	102068668	F102	R13 RELIEF
80x80 cm 32"x32"	702028568	F104	R9 FLAT
	702068368	F105	R11 FLAT
90x90 cm 36"x36"	802028568	F114	R9 FLAT
	802068368	F115	R11 FLAT

Kalınlık / Thickness: 30 mm

EBAT Sizes	ÜRÜN KODU Product Code	FIYAT Price Code	YÜZEY Surfaces
30x60 cm 12"x24"	113028568	F118	R9 FLAT
	113068368	F119	R11 FLAT
45x90 cm 18"x36"	813028568	F122	R9 FLAT
	813068368	F123	R11 FLAT
60x60 cm 24"x24"	103028568	F116	R9 FLAT
	103068368	F117	R11 FLAT
90x90 cm 36"x36"	803028568	F120	R9 FLAT
	803068368	F121	R11 FLAT

R13 - RELIEF

R9 - R11 - FLAT

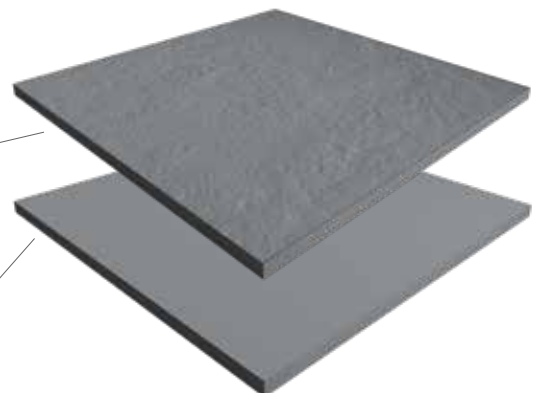

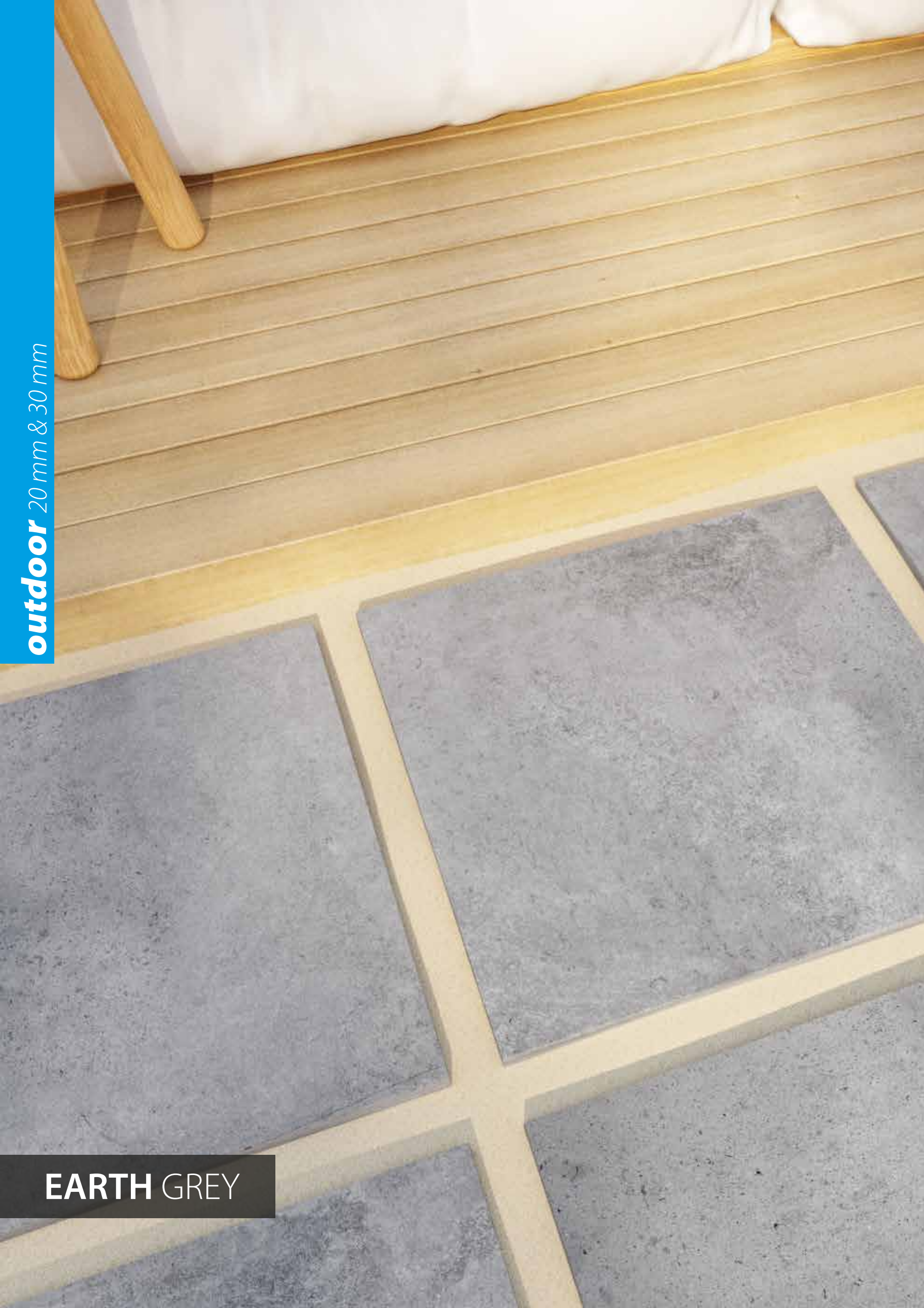

outdoor 20 mm & 30 mm

EARTH GREY

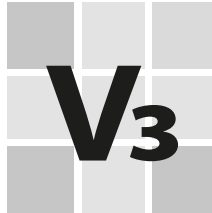
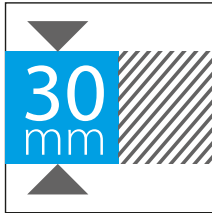

outdoor 20 mm & 30 mm

EARTH GREY



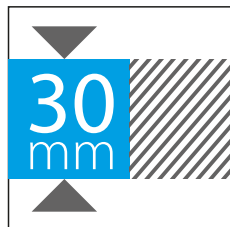
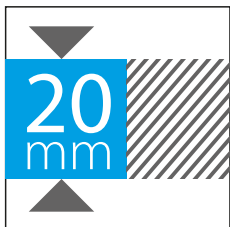
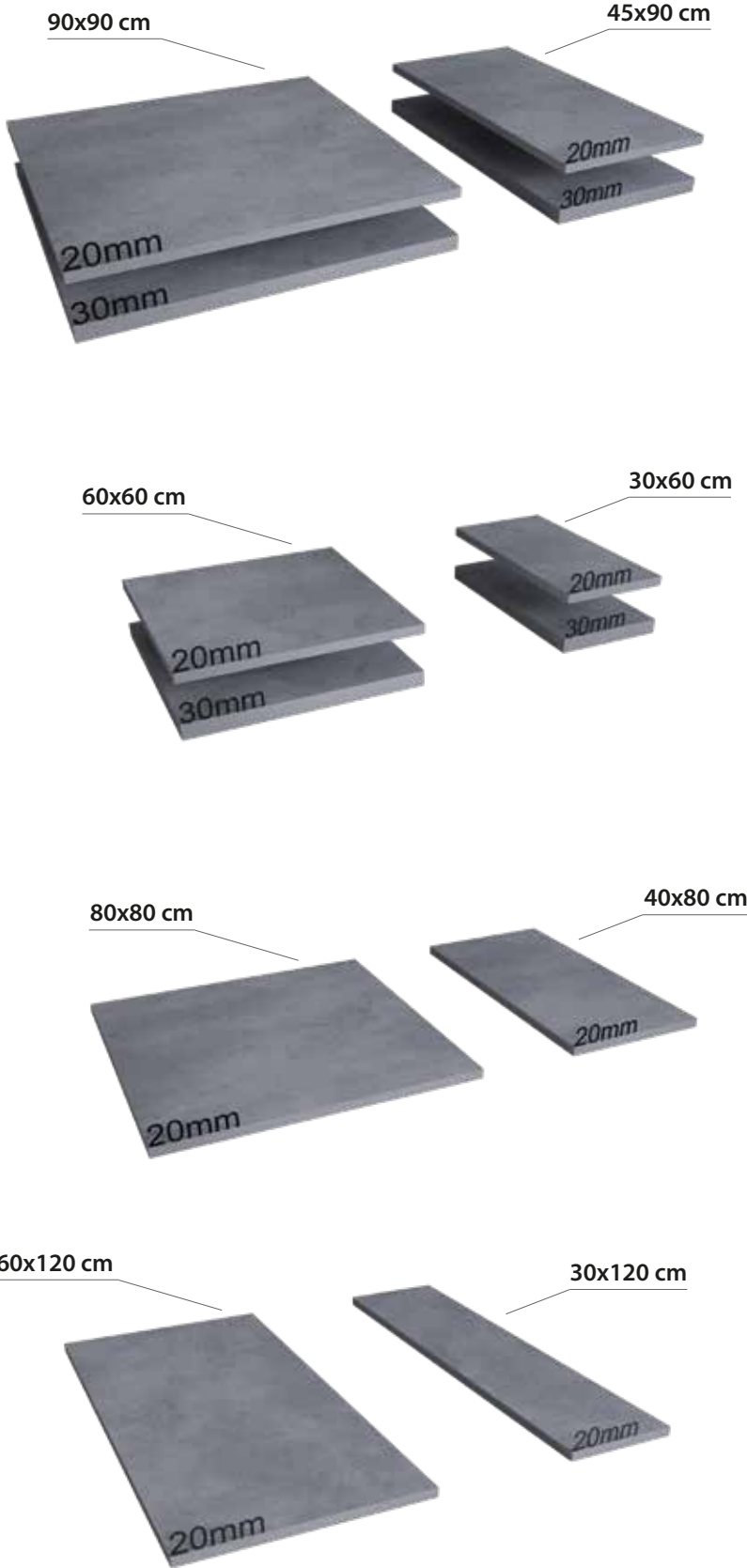

R13 - RELIEF

R9 - R11 - FLAT

Kalınlık / Thickness: 20 mm

EBAT Sizes	ÜRÜN KODU Product Code	FIYAT Price Code	YÜZEY Surfaces
30x120 cm 12"x48"	312028509	F106	R9 FLAT
	312068309	F107	R11 FLAT
	312068609	F107	R13 RELIEF
30x60 cm 12"x24"	112028509	F108	R9 FLAT
	112068309	F109	R11 FLAT
	112068609	F109	R13 RELIEF
40x80 cm 16"x32"	712028509	F110	R9 FLAT
	712068309	F111	R11 FLAT
45x90 cm 18"x36"	812028509	F112	R9 FLAT
	812068309	F113	R11 FLAT
60x120 cm 24"x48"	302028509	F101	R9 FLAT
	302068309	F103	R11 FLAT
	302068609	F103	R13 RELIEF
60x60 cm 24"x24"	102028509	F100	R9 FLAT
	102068309	F102	R11 FLAT
	102068609	F102	R13 RELIEF
80x80 cm 32"x32"	702028509	F104	R9 FLAT
	702068309	F105	R11 FLAT
90x90 cm 36"x36"	802028509	F114	R9 FLAT
	802068309	F115	R11 FLAT

Kalınlık / Thickness: 30 mm

EBAT Sizes	ÜRÜN KODU Product Code	FIYAT Price Code	YÜZEY Surfaces
30x60 cm 12"x24"	113028509	F118	R9 FLAT
	113068309	F119	R11 FLAT
45x90 cm 18"x36"	813028509	F122	R9 FLAT
	813068309	F123	R11 FLAT
60x60 cm 24"x24"	103028509	F116	R9 FLAT
	103068309	F117	R11 FLAT
90x90 cm 36"x36"	803028509	F120	R9 FLAT
	803068309	F121	R11 FLAT

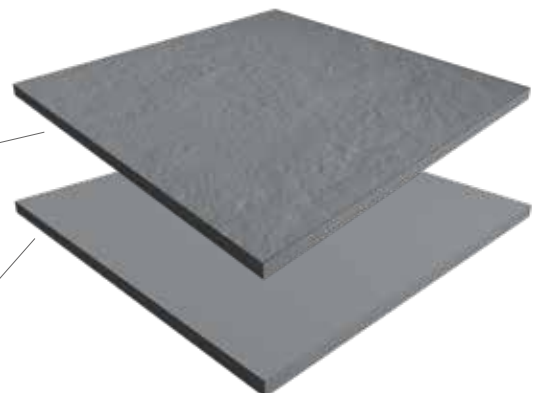



outdoor 20 mm & 30 mm

EARTH WARM GREY

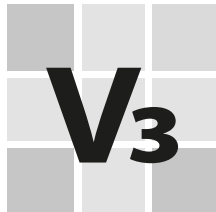
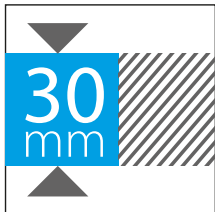



outdoor 20 mm & 30 mm

EARTH WARM GREY

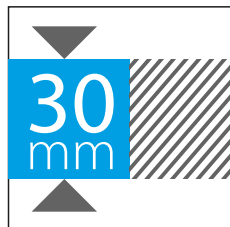
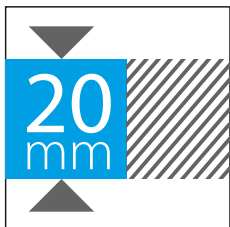
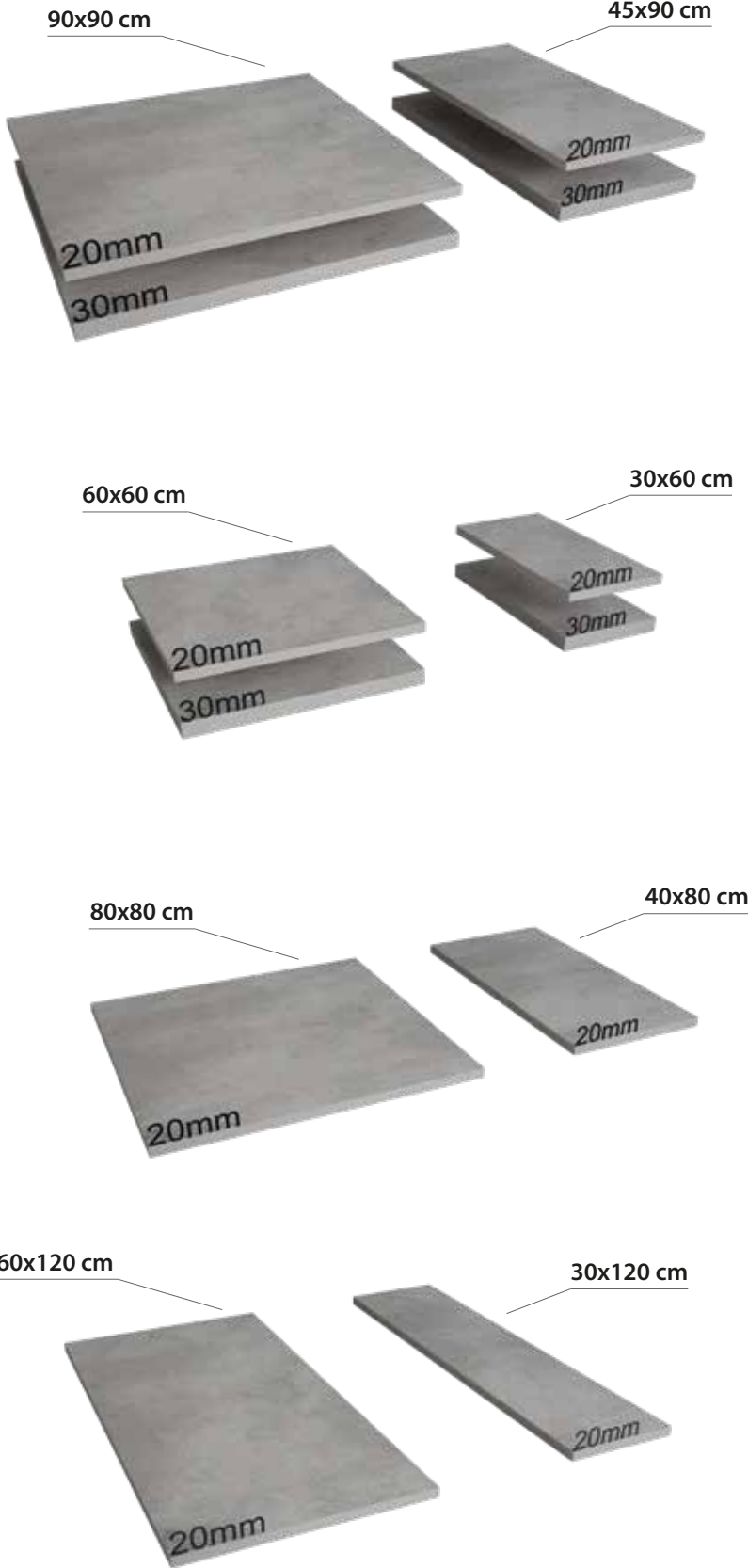

Kalınlık / Thickness: 20 mm

EBAT Sizes	ÜRÜN KODU Product Code	FIYAT Price Code	YÜZEY Surfaces
30x120 cm 12"x48"	312028523	F106	R9 FLAT
	312068323	F107	R11 FLAT
	312068623	F107	R13 RELIEF
30x60 cm 12"x24"	112028523	F108	R9 FLAT
	112068323	F109	R11 FLAT
	112068623	F109	R13 RELIEF
40x80 cm 16"x32"	712028523	F110	R9 FLAT
	712068323	F111	R11 FLAT
45x90 cm 18"x36"	812028523	F112	R9 FLAT
	812068323	F113	R11 FLAT
60x120 cm 24"x48"	302028523	F101	R9 FLAT
	302068323	F103	R11 FLAT
	302068623	F103	R13 RELIEF
60x60 cm 24"x24"	102028523	F100	R9 FLAT
	102068323	F102	R11 FLAT
	102068623	F102	R13 RELIEF
80x80 cm 32"x32"	702028523	F104	R9 FLAT
	702068323	F105	R11 FLAT
90x90 cm 36"x36"	802028523	F114	R9 FLAT
	802068323	F115	R11 FLAT

Kalınlık / Thickness: 30 mm

EBAT Sizes	ÜRÜN KODU Product Code	FIYAT Price Code	YÜZEY Surfaces
30x60 cm 12"x24"	113028523	F118	R9 FLAT
	113068323	F119	R11 FLAT
45x90 cm 18"x36"	813028523	F122	R9 FLAT
	813068323	F123	R11 FLAT
60x60 cm 24"x24"	103028523	F116	R9 FLAT
	103068323	F117	R11 FLAT
90x90 cm 36"x36"	803028523	F120	R9 FLAT
	803068323	F121	R11 FLAT

R13 - RELIEF

R9 - R11 - FLAT

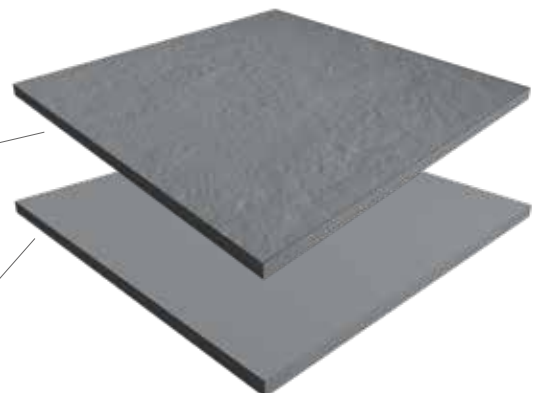

outdoor 20 mm & 30 mm



EARTH WHITE

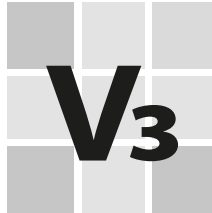
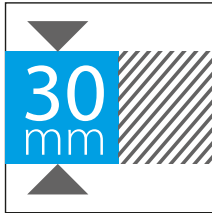

outdoor 20 mm & 30 mm



EARTH WHITE

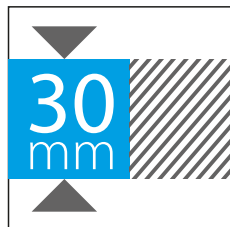
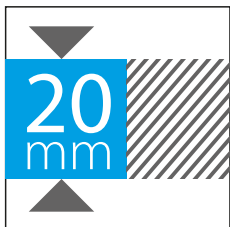
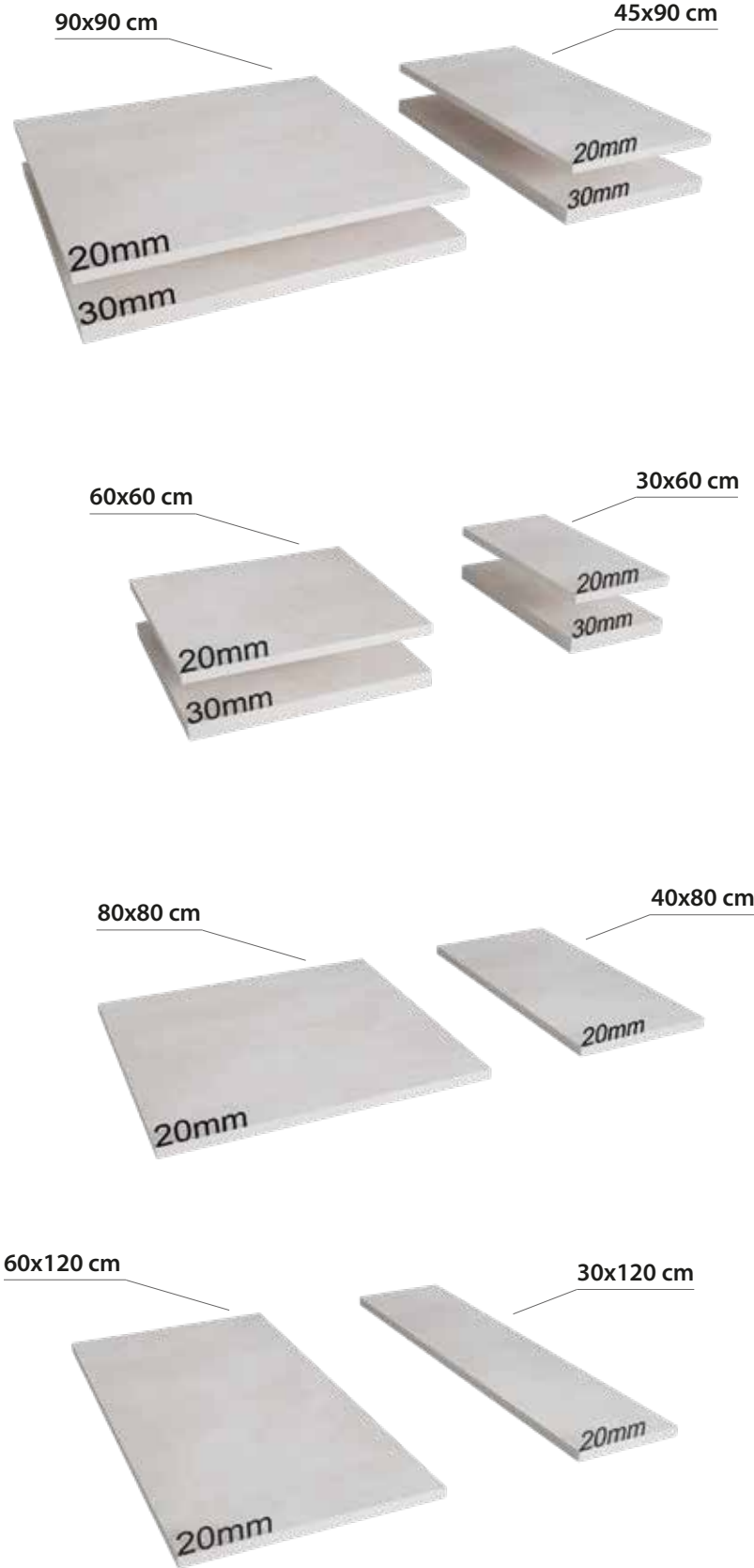

Kalınlık / Thickness: 20 mm

EBAT Sizes	ÜRÜN KODU Product Code	FIYAT Price Code	YÜZEY Surfaces
30x120 cm 12"x48"	312028510	F106	R9 FLAT
	312068310	F107	R11 FLAT
	312068610	F107	R13 RELIEF
30x60 cm 12"x24"	112028510	F108	R9 FLAT
	112068310	F109	R11 FLAT
	112068610	F109	R13 RELIEF
40x80 cm 16"x32"	712028510	F110	R9 FLAT
	712068310	F111	R11 FLAT
45x90 cm 18"x36"	812028510	F112	R9 FLAT
	812068310	F113	R11 FLAT
60x120 cm 24"x48"	302028510	F101	R9 FLAT
	302068310	F103	R11 FLAT
	302068610	F103	R13 RELIEF
60x60 cm 24"x24"	102028510	F100	R9 FLAT
	102068310	F102	R11 FLAT
	102068610	F102	R13 RELIEF
80x80 cm 32"x32"	702028510	F104	R9 FLAT
	702068310	F105	R11 FLAT
90x90 cm 36"x36"	802028510	F114	R9 FLAT
	802068310	F115	R11 FLAT

Kalınlık / Thickness: 30 mm

EBAT Sizes	ÜRÜN KODU Product Code	FIYAT Price Code	YÜZEY Surfaces
30x60 cm 12"x24"	113028510	F118	R9 FLAT
	113068310	F119	R11 FLAT
45x90 cm 18"x36"	813028510	F122	R9 FLAT
	813068310	F123	R11 FLAT
60x60 cm 24"x24"	103028510	F116	R9 FLAT
	103068310	F117	R11 FLAT
90x90 cm 36"x36"	803028510	F120	R9 FLAT
	803068310	F121	R11 FLAT

R13 - RELIEF

R9 - R11 - FLAT

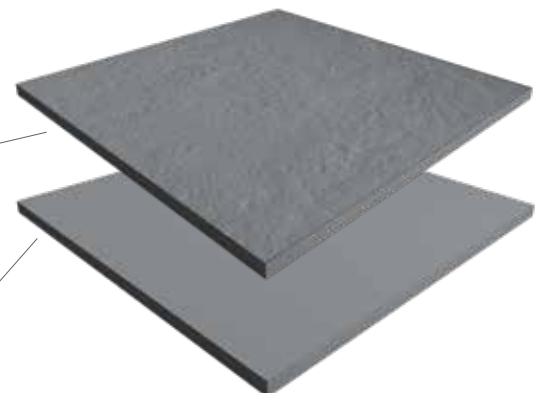

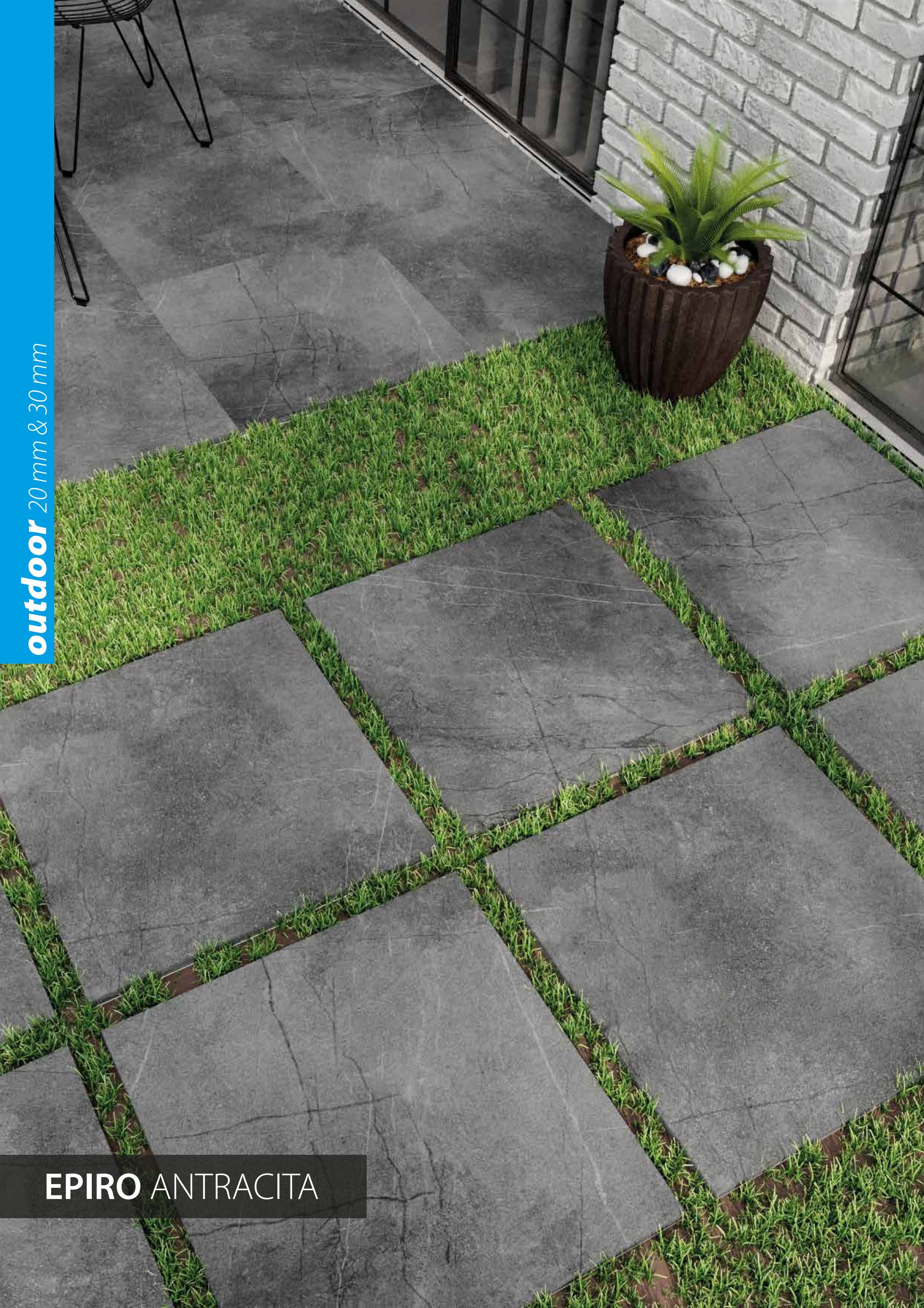

outdoor 20 mm & 30 mm

EPIRO ANTRACITA

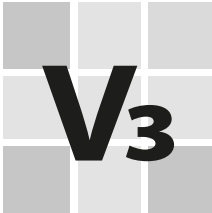
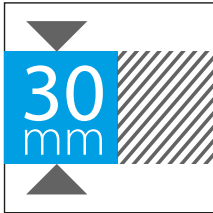
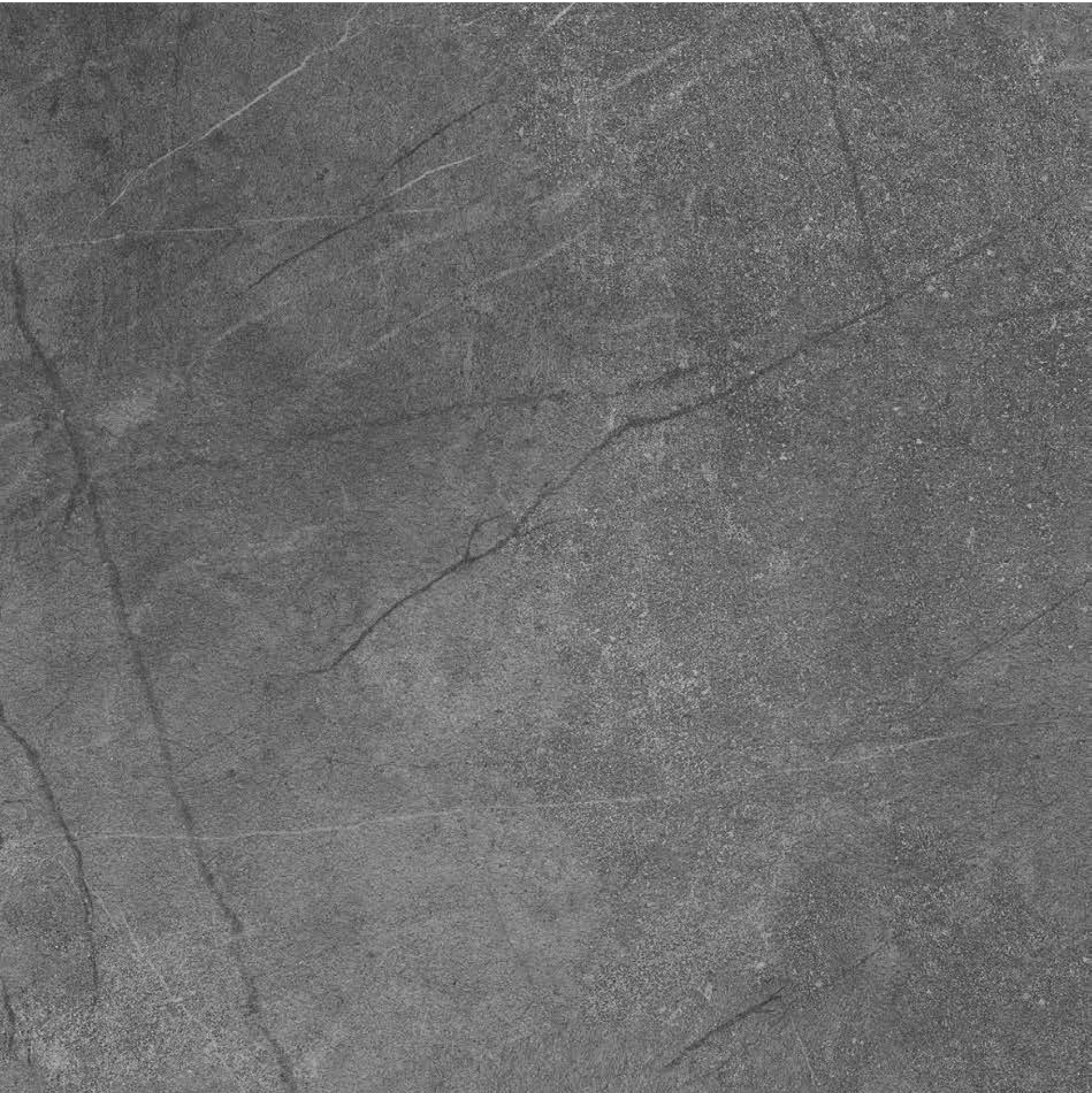

outdoor 20 mm & 30 mm

EPIRO ANTRACITA



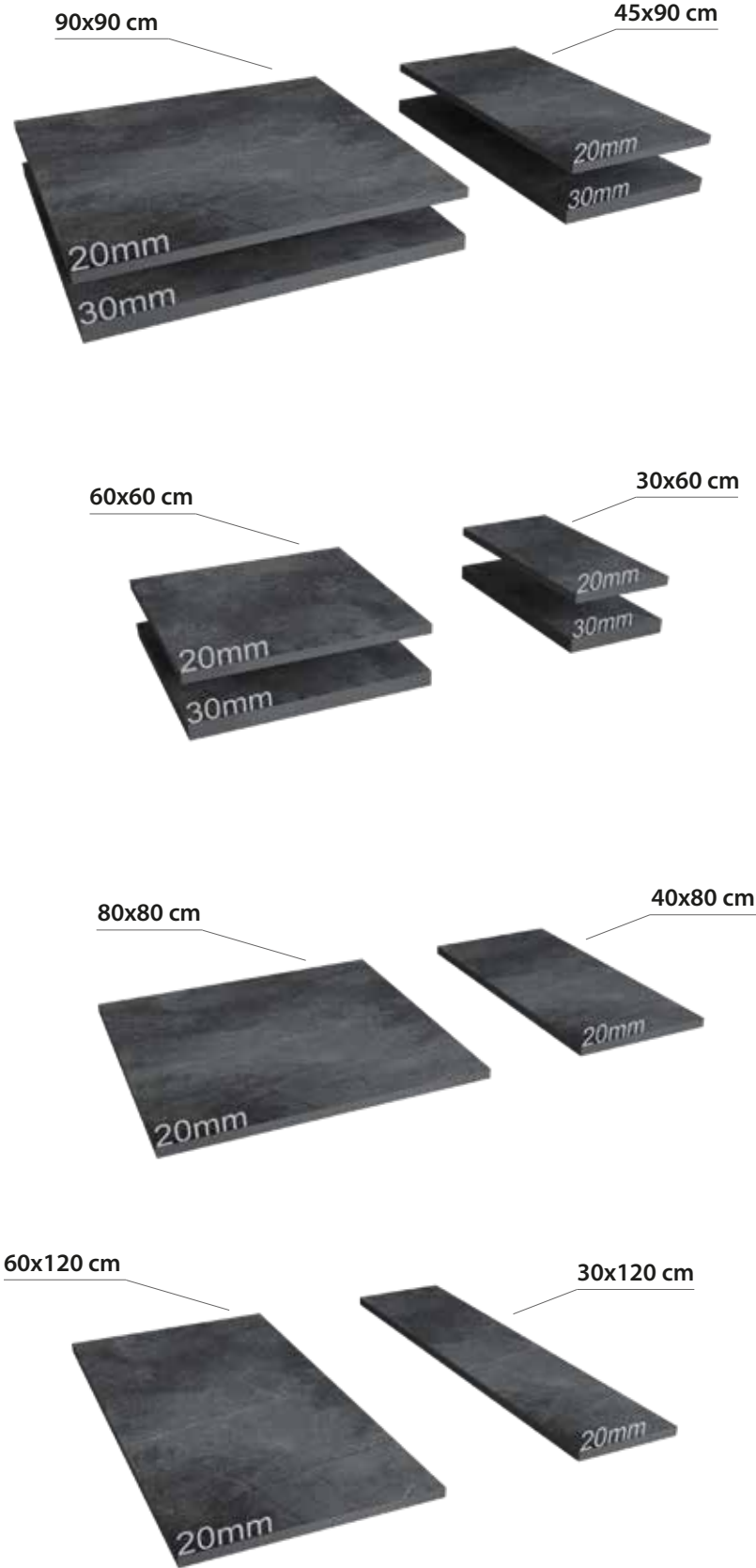

Kalınlık / Thickness: 20 mm

EBAT Sizes	ÜRÜN KODU Product Code	FIYAT Price Code	YÜZEY Surfaces
30x120 cm 12"x48"	312059968	F106	R9 FLAT
	312068168	F107	R11 FLAT
	312069668	F107	R13 RELIEF
30x60 cm 12"x24"	112059968	F108	R9 FLAT
	112068168	F109	R11 FLAT
	112069668	F109	R13 RELIEF
40x80 cm 16"x32"	712059968	F110	R9 FLAT
	712068168	F111	R11 FLAT
45x90 cm 18"x36"	812059968	F112	R9 FLAT
	812068168	F113	R11 FLAT
60x120 cm 24"x48"	302059968	F101	R9 FLAT
	302068168	F103	R11 FLAT
	302069668	F103	R13 RELIEF
60x60 cm 24"x24"	102059968	F100	R9 FLAT
	102068168	F102	R11 FLAT
	102069668	F102	R13 RELIEF
80x80 cm 32"x32"	702059968	F104	R9 FLAT
	702068168	F105	R11 FLAT
90x90 cm 36"x36"	802059968	F114	R9 FLAT
	802068168	F115	R11 FLAT

Kalınlık / Thickness: 30 mm

EBAT Sizes	ÜRÜN KODU Product Code	FIYAT Price Code	YÜZEY Surfaces
30x60 cm 12"x24"	113059968	F118	R9 FLAT
	113068168	F119	R11 FLAT
45x90 cm 18"x36"	813059968	F122	R9 FLAT
	813068168	F123	R11 FLAT
60x60 cm 24"x24"	103059968	F116	R9 FLAT
	103068168	F117	R11 FLAT
90x90 cm 36"x36"	803059968	F120	R9 FLAT
	803068168	F121	R11 FLAT

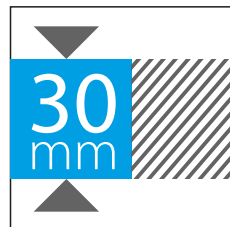
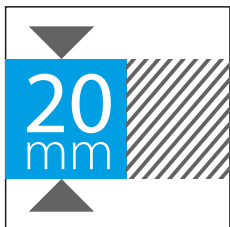

R13 - RELIEF

R9 - R11 - FLAT

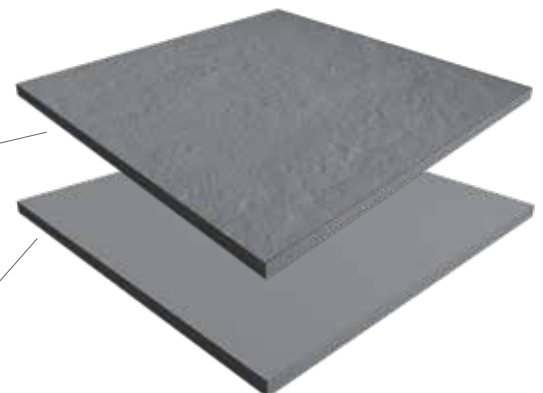

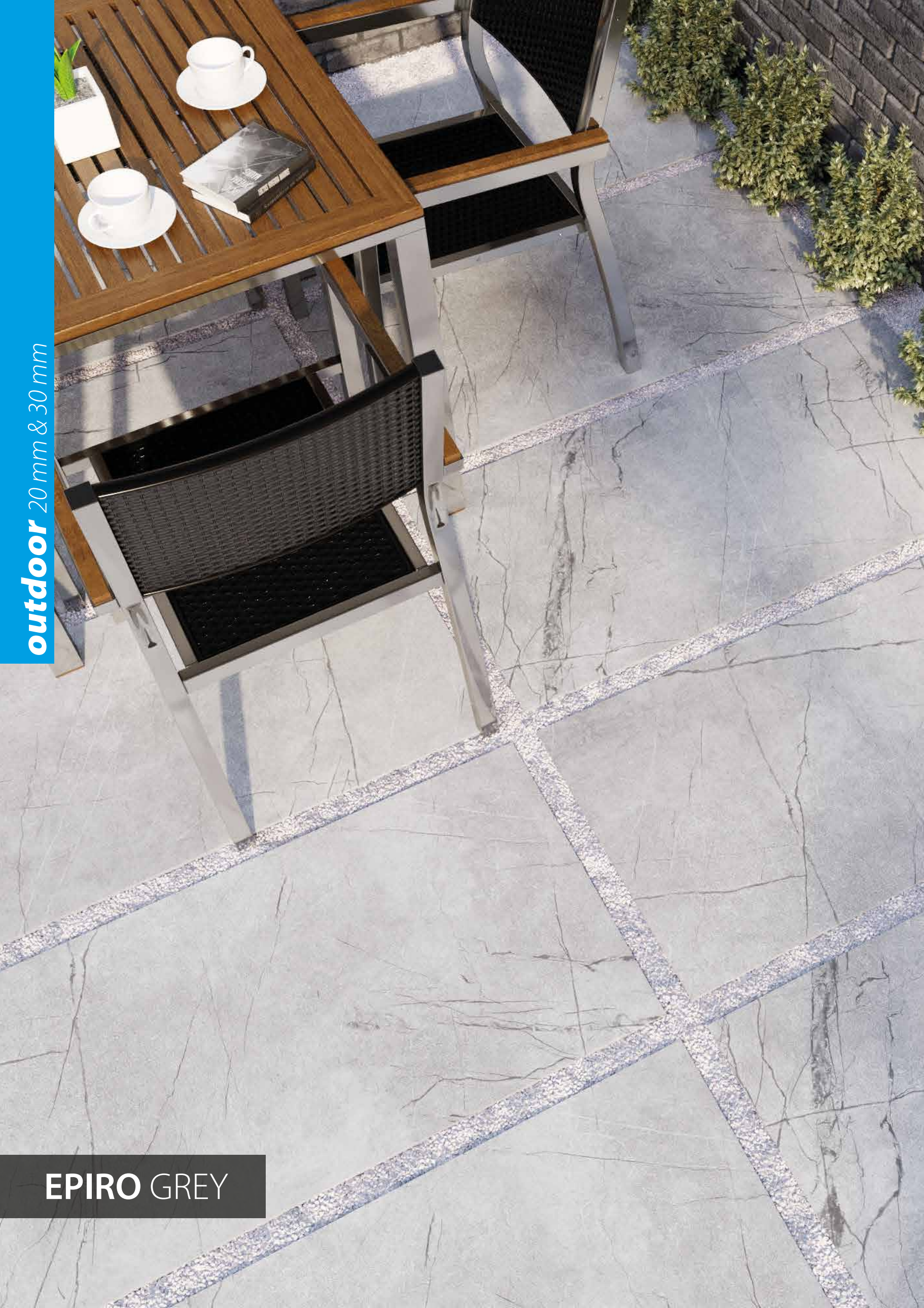

outdoor 20 mm & 30 mm

EPIRO GREY

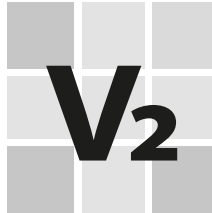
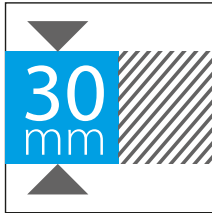

outdoor 20 mm & 30 mm



EPIRO GREY

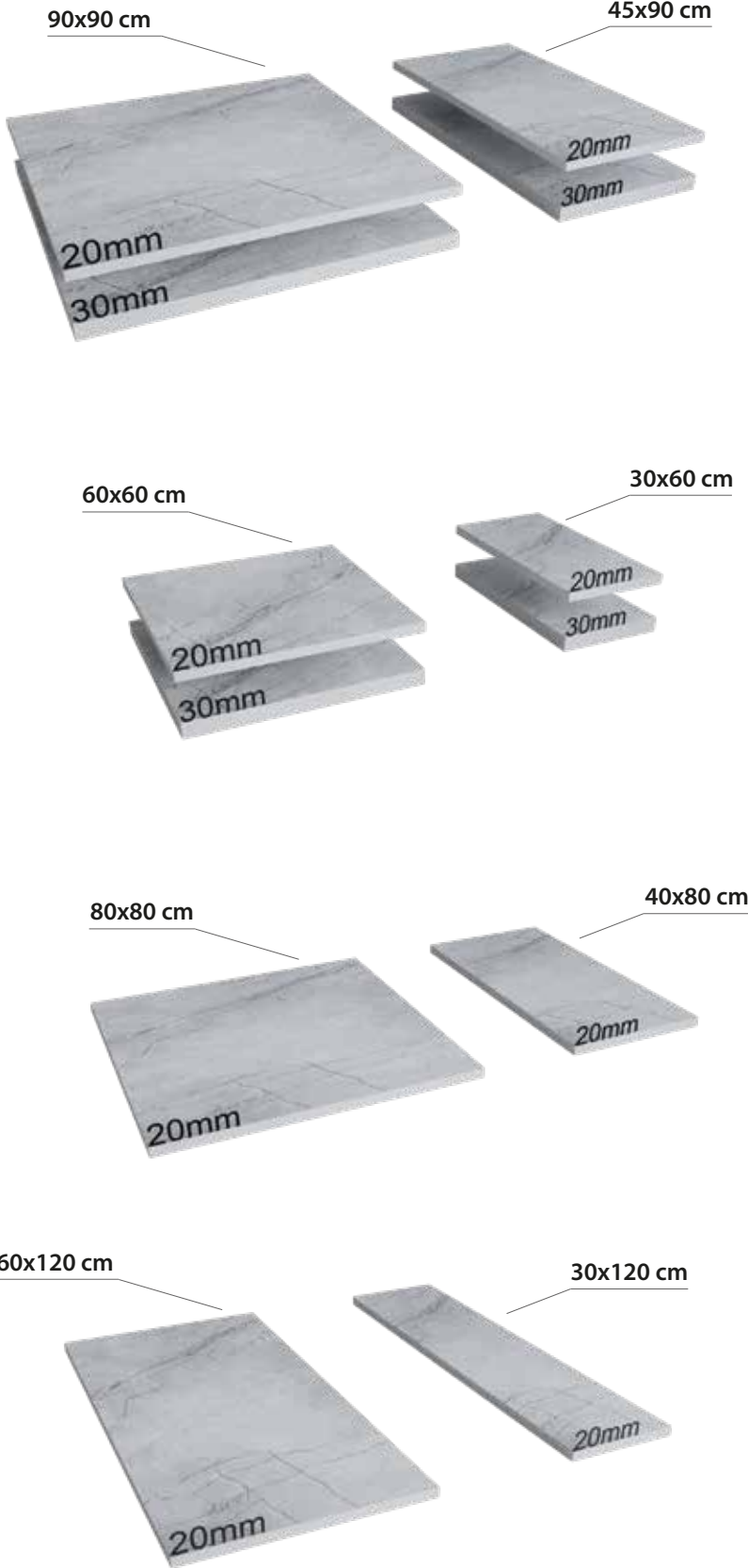

Kalınlık / Thickness: 20 mm

EBAT Sizes	ÜRÜN KODU Product Code	FIYAT Price Code	YÜZEY Surfaces
30x120 cm 12"x48"	312059909	F106	R9 FLAT
	312068109	F107	R11 FLAT
	312069609	F107	R13 RELIEF
30x60 cm 12"x24"	112059909	F108	R9 FLAT
	112068109	F109	R11 FLAT
	112069609	F109	R13 RELIEF
40x80 cm 16"x32"	712059909	F110	R9 FLAT
	712068109	F111	R11 FLAT
45x90 cm 18"x36"	812059909	F112	R9 FLAT
	812068109	F113	R11 FLAT
60x120 cm 24"x48"	302059909	F101	R9 FLAT
	302068109	F103	R11 FLAT
	302069609	F103	R13 RELIEF
60x60 cm 24"x24"	102059909	F100	R9 FLAT
	102068109	F102	R11 FLAT
	102069609	F102	R13 RELIEF
80x80 cm 32"x32"	702059909	F104	R9 FLAT
	702068109	F105	R11 FLAT
90x90 cm 36"x36"	802059909	F114	R9 FLAT
	802068109	F115	R11 FLAT

Kalınlık / Thickness: 30 mm

EBAT Sizes	ÜRÜN KODU Product Code	FIYAT Price Code	YÜZEY Surfaces
30x60 cm 12"x24"	113059909	F118	R9 FLAT
	113068109	F119	R11 FLAT
45x90 cm 18"x36"	813059909	F122	R9 FLAT
	813068109	F123	R11 FLAT
60x60 cm 24"x24"	103059909	F116	R9 FLAT
	103068109	F117	R11 FLAT
90x90 cm 36"x36"	803059909	F120	R9 FLAT
	803068109	F121	R11 FLAT

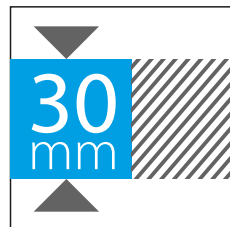
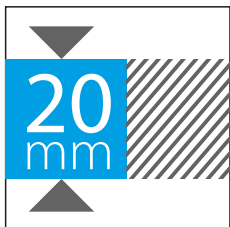

R13 - RELIEF

R9 - R11 - FLAT

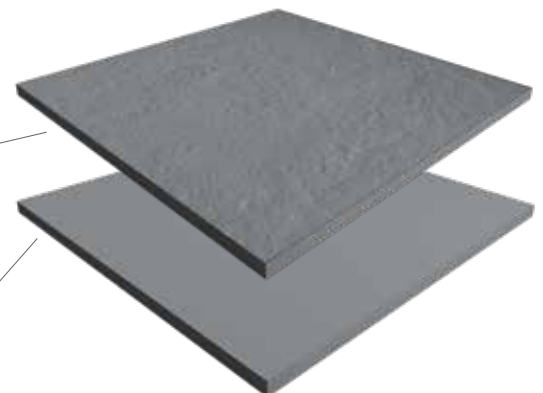



outdoor 20 mm & 30 mm

GRAVEL ANTRACITA

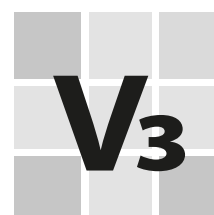
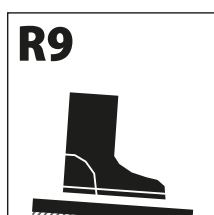
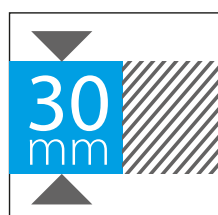
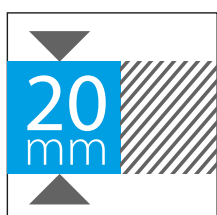

outdoor 20 mm & 30 mm

GRAVEL ANTRACITA



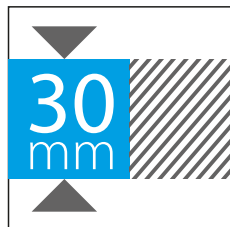
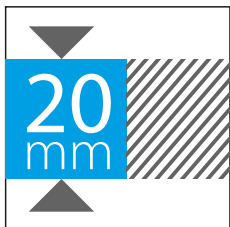
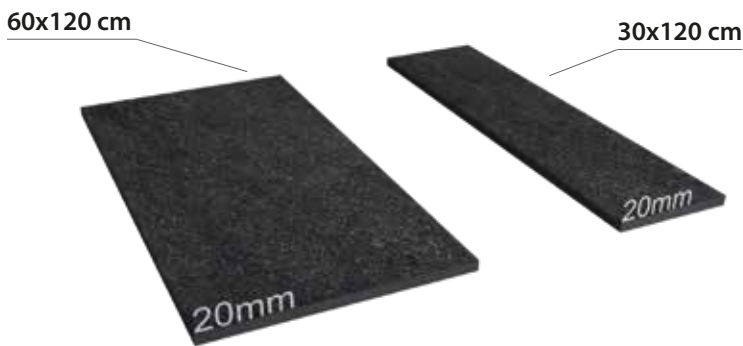
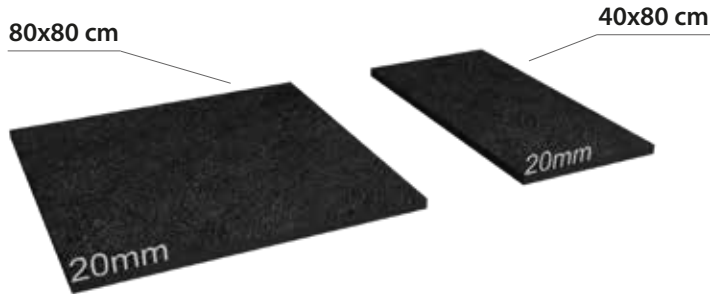
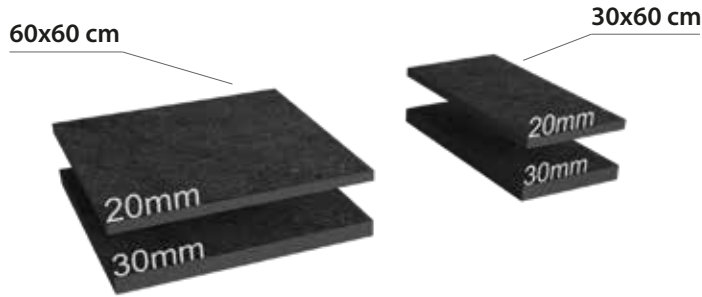
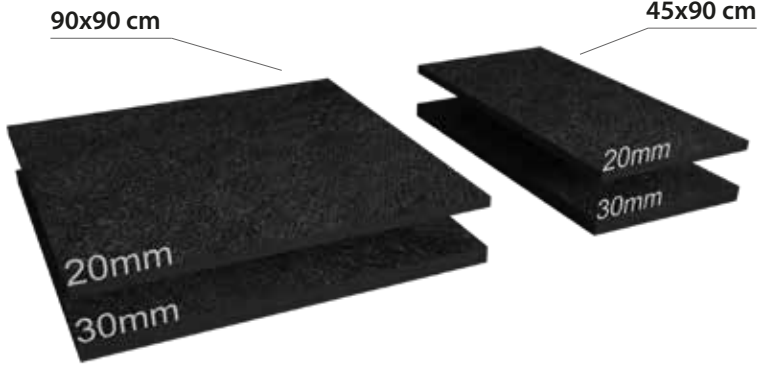

R13 - RELIEF

R9 - R11 - FLAT

Kalınlık / Thickness: 20 mm

EBAT Sizes	ÜRÜN KODU Product Code	FIYAT Price Code	YÜZEY Surfaces
30x120 cm 12"x48"	312070368	F106	R9 FLAT
	312070468	F107	R11 FLAT
	312070268	F107	R13 RELIEF
30x60 cm 12"x24"	112070368	F108	R9 FLAT
	112070468	F109	R11 FLAT
	112070268	F109	R13 RELIEF
40x80 cm 16"x32"	712070368	F110	R9 FLAT
	712070468	F111	R11 FLAT
45x90 cm 18"x36"	812070368	F112	R9 FLAT
	812070468	F113	R11 FLAT
60x120 cm 24"x48"	302070368	F101	R9 FLAT
	302070468	F103	R11 FLAT
	302070268	F103	R13 RELIEF
60x60 cm 24"x24"	102070368	F100	R9 FLAT
	102070468	F102	R11 FLAT
	102070268	F102	R13 RELIEF
80x80 cm 32"x32"	702070368	F104	R9 FLAT
	702070468	F105	R11 FLAT
90x90 cm 36"x36"	802070368	F114	R9 FLAT
	802070468	F115	R11 FLAT

Kalınlık / Thickness: 30 mm

EBAT Sizes	ÜRÜN KODU Product Code	FIYAT Price Code	YÜZEY Surfaces
30x60 cm 12"x24"	113070368	F118	R9 FLAT
	113070468	F119	R11 FLAT
	113070268	F119	R13 RELIEF
45x90 cm 18"x36"	813070368	F122	R9 FLAT
	813070468	F123	R11 FLAT
	813070268	F123	R13 RELIEF
60x60 cm 24"x24"	103070368	F116	R9 FLAT
	103070468	F117	R11 FLAT
	103070268	F117	R13 RELIEF
90x90 cm 36"x36"	803070368	F120	R9 FLAT
	803070468	F121	R11 FLAT
	803070268	F121	R13 RELIEF

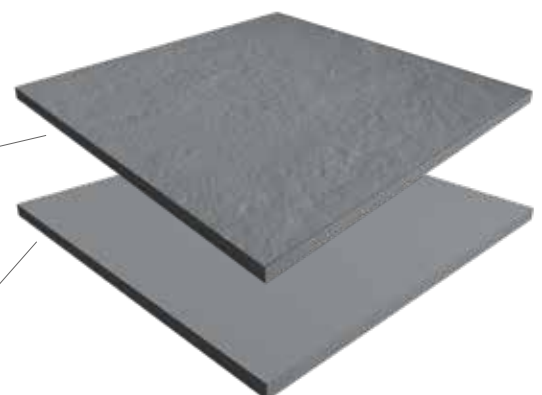

outdoor 20 mm & 30 mm



GRAVEL GREY

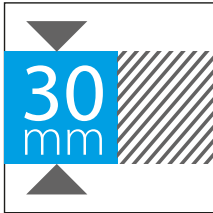

outdoor 20 mm & 30 mm



GRAVEL GREY

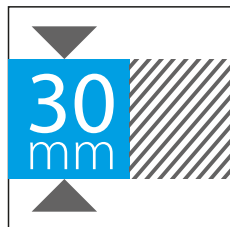
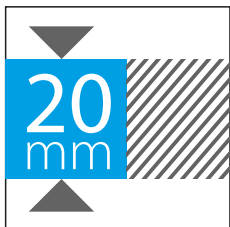
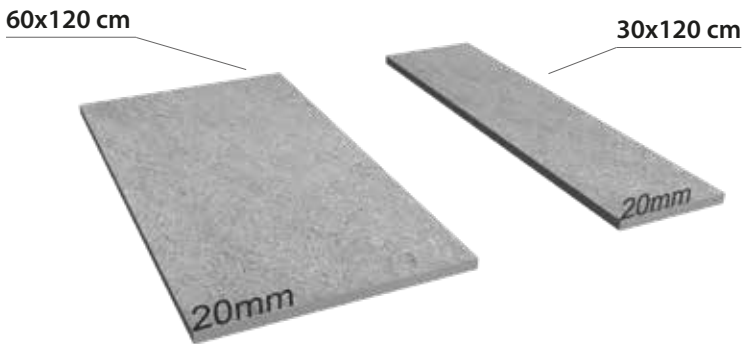
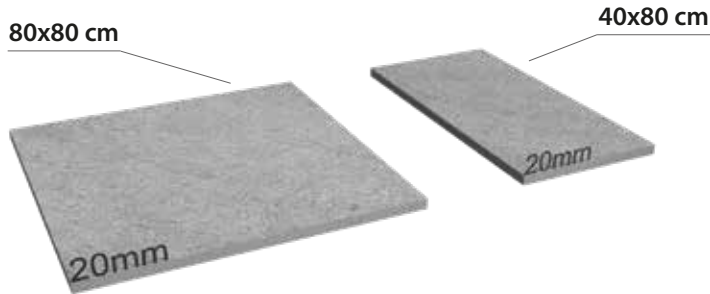
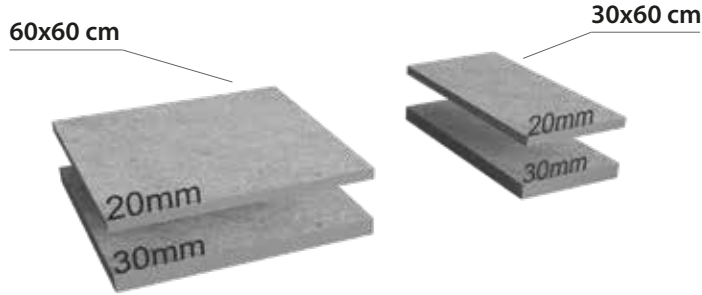
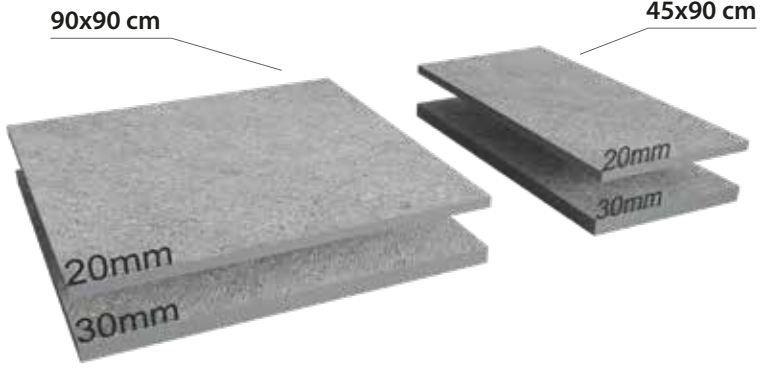

Kalınlık / Thickness: 20 mm

EBAT Sizes	ÜRÜN KODU Product Code	FIYAT Price Code	YÜZEY Surfaces
30x120 cm 12"x48"	312070309	F106	R9 FLAT
	312070409	F107	R11 FLAT
	312070209	F107	R13 RELIEF
30x60 cm 12"x24"	112070309	F108	R9 FLAT
	112070409	F109	R11 FLAT
	112070209	F109	R13 RELIEF
40x80 cm 16"x32"	712070309	F110	R9 FLAT
	712070409	F111	R11 FLAT
45x90 cm 18"x36"	812070309	F112	R9 FLAT
	812070409	F113	R11 FLAT
60x120 cm 24"x48"	302070309	F101	R9 FLAT
	302070409	F103	R11 FLAT
	302070209	F103	R13 RELIEF
60x60 cm 24"x24"	102070309	F100	R9 FLAT
	102070409	F102	R11 FLAT
	102070209	F102	R13 RELIEF
80x80 cm 32"x32"	702070309	F104	R9 FLAT
	702070409	F105	R11 FLAT
90x90 cm 36"x36"	802070309	F114	R9 FLAT
	802070409	F115	R11 FLAT

Kalınlık / Thickness: 30 mm

EBAT Sizes	ÜRÜN KODU Product Code	FIYAT Price Code	YÜZEY Surfaces
30x60 cm 12"x24"	113070309	F118	R9 FLAT
	113070409	F119	R11 FLAT
	113070209	F119	R13 RELIEF
45x90 cm 18"x36"	813070309	F122	R9 FLAT
	813070409	F123	R11 FLAT
	813070209	F123	R13 RELIEF
60x60 cm 24"x24"	103070309	F116	R9 FLAT
	103070409	F117	R11 FLAT
	103070209	F117	R13 RELIEF
90x90 cm 36"x36"	803070309	F120	R9 FLAT
	803070409	F121	R11 FLAT
	803070209	F121	R13 RELIEF

R13 - RELIEF

R9 - R11 - FLAT

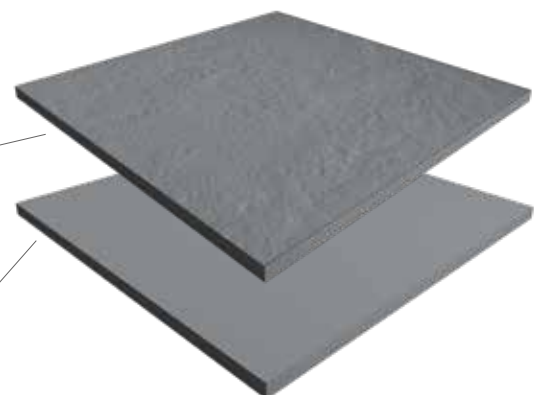



outdoor 20 mm & 30 mm

MAJA IVORY

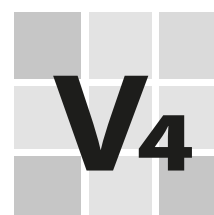
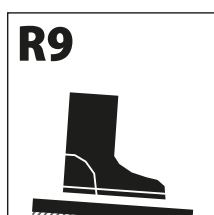
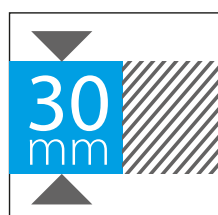
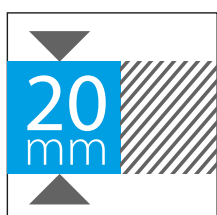

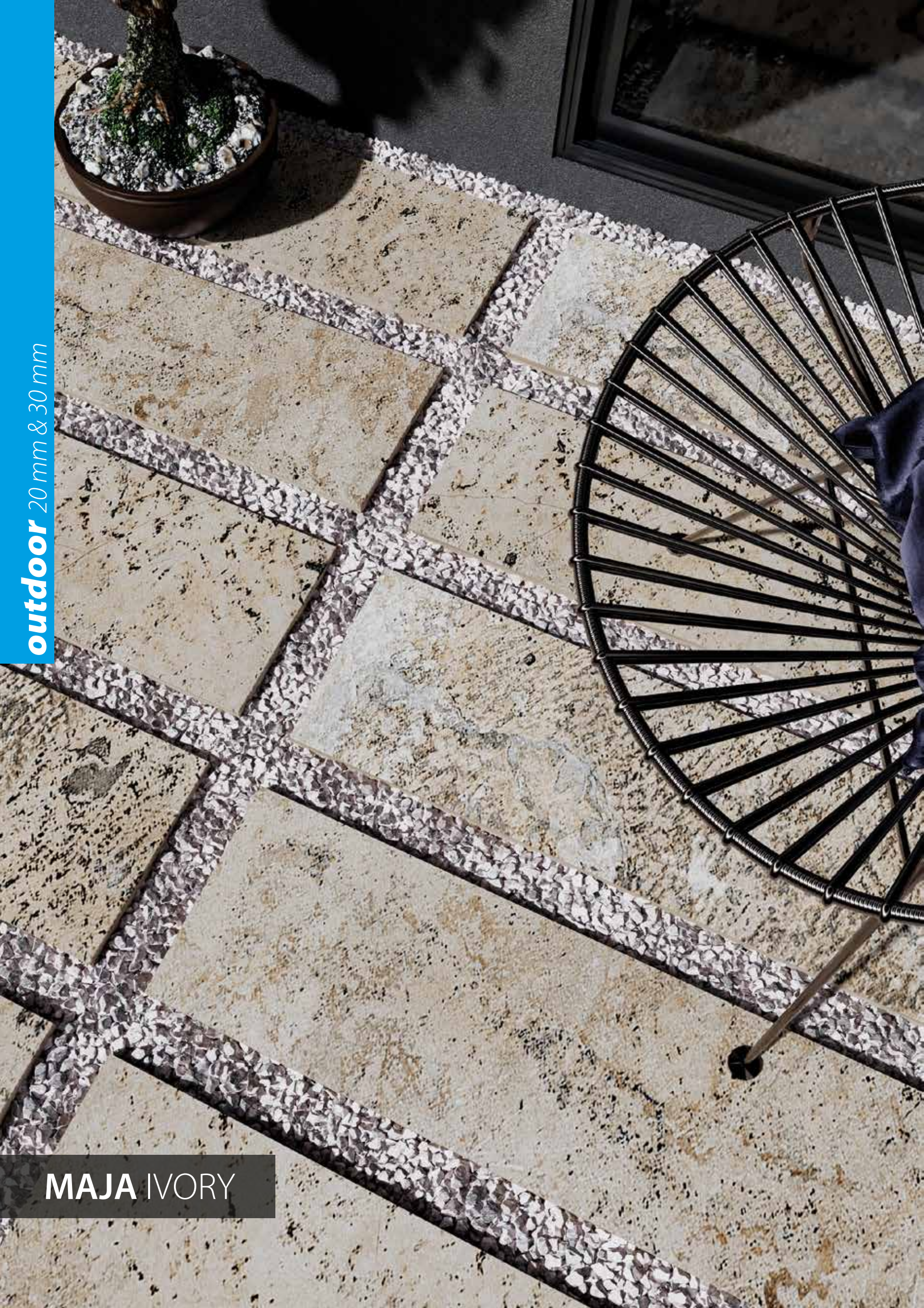

outdoor 20 mm & 30 mm

MAJA IVORY

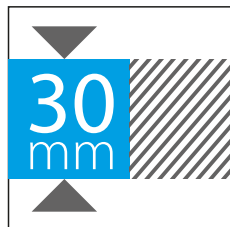
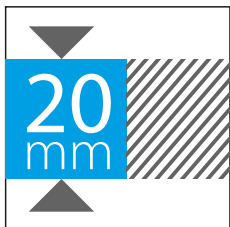
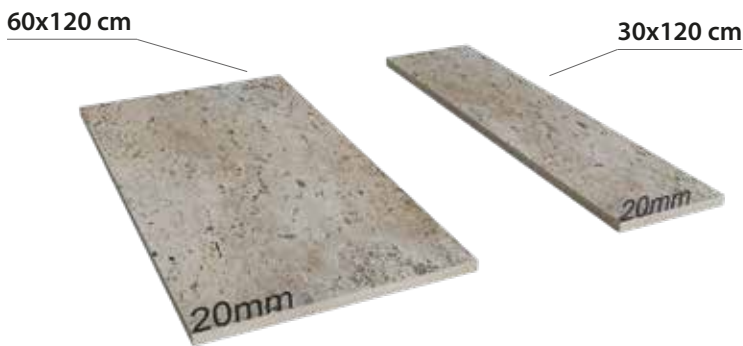

Kalınlık / Thickness: 20 mm

EBAT Sizes	ÜRÜN KODU Product Code	FIYAT Price Code	YÜZEY Surfaces
30x120 cm 12"x48"	312070774	F106	R9 FLAT
	312070874	F107	R11 FLAT
30x60 cm 12"x24"	112070774	F108	R9 FLAT
	112070874	F109	R11 FLAT
	112070674	F109	R13 RELIEF
40x80 cm 16"x32"	712070774	F110	R9 FLAT
	712070874	F111	R11 FLAT
45x90 cm 18"x36"	812070774	F112	R9 FLAT
	812070874	F113	R11 FLAT
60x120 cm 24"x48"	302070774	F101	R9 FLAT
	302070874	F103	R11 FLAT
60x60 cm 24"x24"	102070774	F100	R9 FLAT
	102070874	F102	R11 FLAT
	102070674	F102	R13 RELIEF
80x80 cm 32"x32"	702070774	F104	R9 FLAT
	702070874	F105	R11 FLAT
90x90 cm 36"x36"	802070774	F114	R9 FLAT
	802070874	F115	R11 FLAT

Kalınlık / Thickness: 30 mm

EBAT Sizes	ÜRÜN KODU Product Code	FIYAT Price Code	YÜZEY Surfaces
30x60 cm 12"x24"	113070774	F118	R9 FLAT
	113070874	F119	R11 FLAT
	113070674	F119	R13 RELIEF
45x90 cm 18"x36"	813070774	F122	R9 FLAT
	813070874	F123	R11 FLAT
60x60 cm 24"x24"	103070774	F116	R9 FLAT
	103070874	F117	R11 FLAT
	103070674	F117	R13 RELIEF
90x90 cm 36"x36"	803070774	F120	R9 FLAT
	803070874	F121	R11 FLAT

R13 - RELIEF

R9 - R11 - FLAT

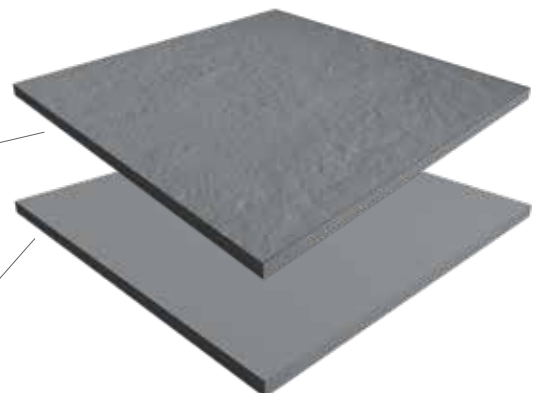

outdoor 20 mm & 30 mm



MERCURY ANTRACITA

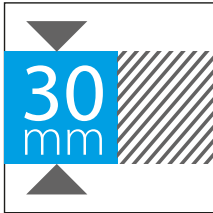



outdoor 20 mm & 30 mm

MERCURY ANTRACITA

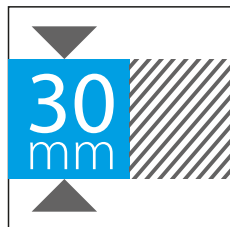
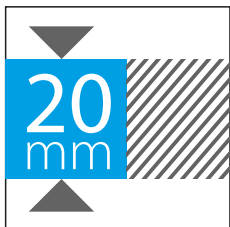
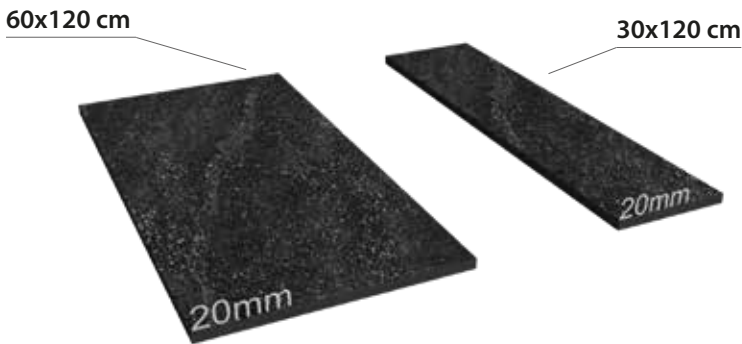
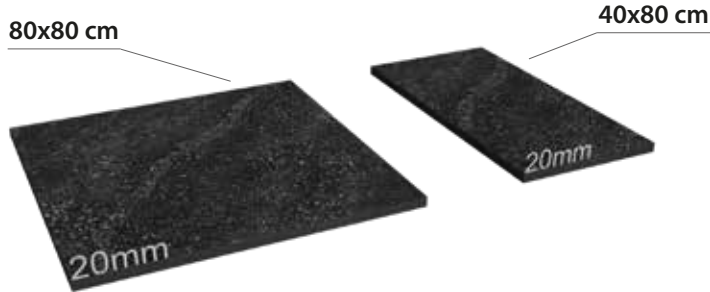
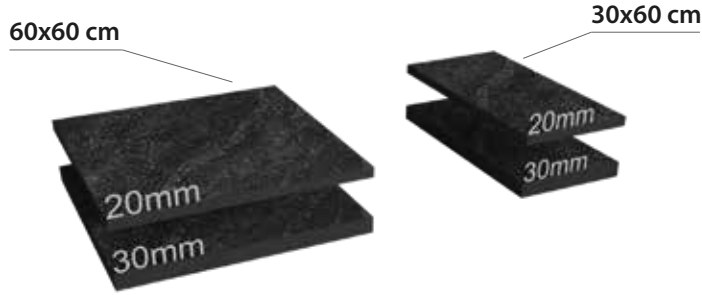
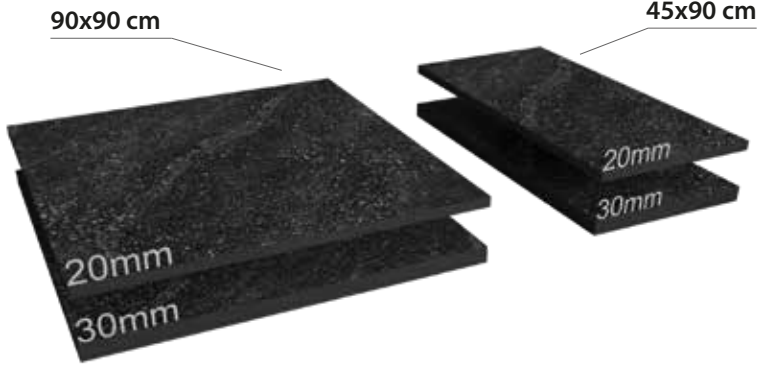

R13 - RELIEF

R9 - R11 - FLAT

Kalınlık / Thickness: 20 mm

EBAT Sizes	ÜRÜN KODU Product Code	FIYAT Price Code	YÜZEY Surfaces
30x120 cm 12"x48"	312071168	F106	R9 FLAT
	312071268	F107	R11 FLAT
	312071068	F107	R13 RELIEF
30x60 cm 12"x24"	112071168	F108	R9 FLAT
	112071268	F109	R11 FLAT
	112071068	F109	R13 RELIEF
40x80 cm 16"x32"	712071168	F110	R9 FLAT
	712071268	F111	R11 FLAT
45x90 cm 18"x36"	812071168	F112	R9 FLAT
	812071268	F113	R11 FLAT
60x120 cm 24"x48"	302071168	F101	R9 FLAT
	302071268	F103	R11 FLAT
	302071068	F103	R13 RELIEF
60x60 cm 24"x24"	102071168	F100	R9 FLAT
	102071268	F102	R11 FLAT
	102071068	F102	R13 RELIEF
80x80 cm 32"x32"	702071168	F104	R9 FLAT
	702071268	F105	R11 FLAT
90x90 cm 36"x36"	802071168	F114	R9 FLAT
	802071268	F115	R11 FLAT

Kalınlık / Thickness: 30 mm

EBAT Sizes	ÜRÜN KODU Product Code	FIYAT Price Code	YÜZEY Surfaces
30x60 cm 12"x24"	113071168	F118	R9 FLAT
	113071268	F119	R11 FLAT
	113071068	F119	R13 RELIEF
45x90 cm 18"x36"	813071168	F122	R9 FLAT
	813071268	F123	R11 FLAT
	813071068	F123	R13 RELIEF
60x60 cm 24"x24"	103071168	F116	R9 FLAT
	103071268	F117	R11 FLAT
	103071068	F117	R13 RELIEF
90x90 cm 36"x36"	803071168	F120	R9 FLAT
	803071268	F121	R11 FLAT
	803071068	F121	R13 RELIEF

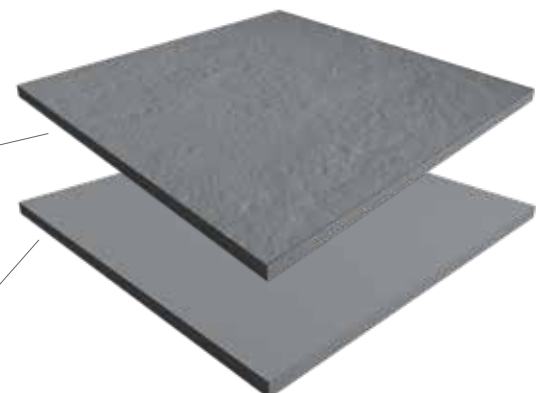

outdoor 20 mm & 30 mm

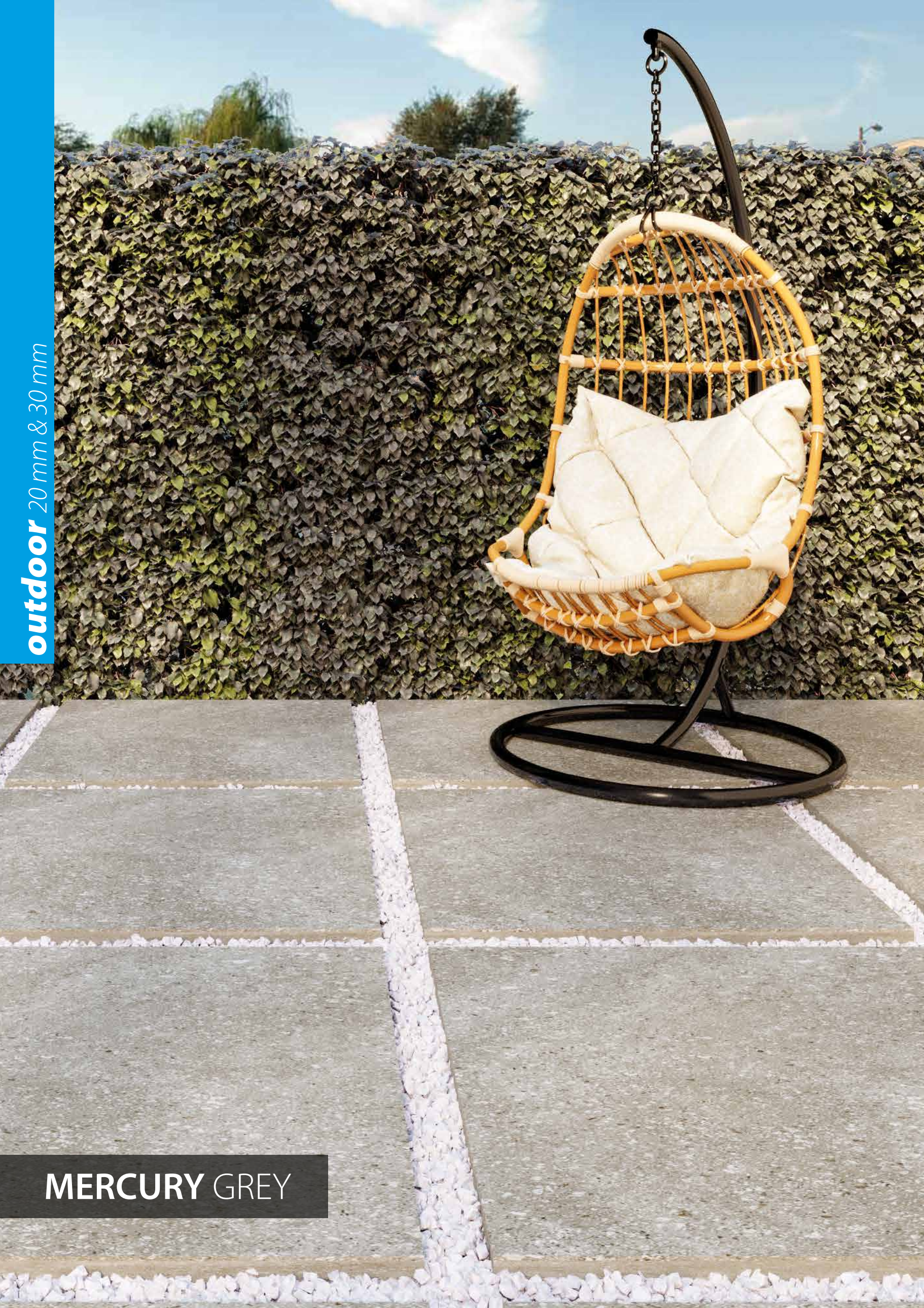

MERCURY GREY

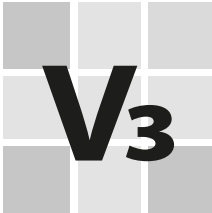
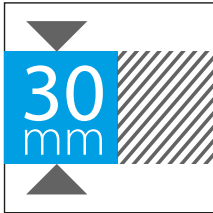



outdoor 20 mm & 30 mm

MERCURY GREY

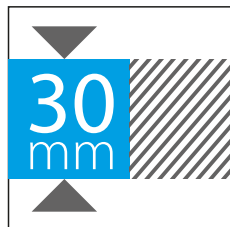
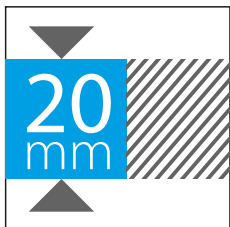
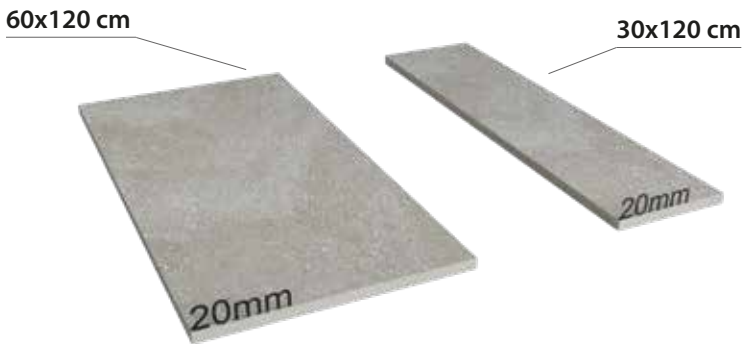
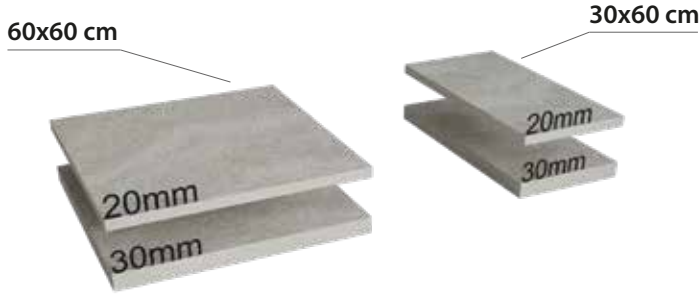

R13 - RELIEF

R9 - R11 - FLAT

Kalınlık / Thickness: 20 mm

EBAT Sizes	ÜRÜN KODU Product Code	FIYAT Price Code	YÜZEY Surfaces
30x120 cm 12"x48"	312071109	F106	R9 FLAT
	312071209	F107	R11 FLAT
	312071009	F107	R13 RELIEF
30x60 cm 12"x24"	112071109	F108	R9 FLAT
	112071209	F109	R11 FLAT
	112071009	F109	R13 RELIEF
40x80 cm 16"x32"	712071109	F110	R9 FLAT
	712071209	F111	R11 FLAT
45x90 cm 18"x36"	812071109	F112	R9 FLAT
	812071209	F113	R11 FLAT
60x120 cm 24"x48"	302071109	F101	R9 FLAT
	302071209	F103	R11 FLAT
	302071009	F103	R13 RELIEF
60x60 cm 24"x24"	102071109	F100	R9 FLAT
	102071209	F102	R11 FLAT
	102071009	F102	R13 RELIEF
80x80 cm 32"x32"	702071109	F104	R9 FLAT
	702071209	F105	R11 FLAT
90x90 cm 36"x36"	802071109	F114	R9 FLAT
	802071209	F115	R11 FLAT

Kalınlık / Thickness: 30 mm

EBAT Sizes	ÜRÜN KODU Product Code	FIYAT Price Code	YÜZEY Surfaces
30x60 cm 12"x24"	113071109	F118	R9 FLAT
	113071209	F119	R11 FLAT
	113071009	F119	R13 RELIEF
45x90 cm 18"x36"	813071109	F122	R9 FLAT
	813071209	F123	R11 FLAT
	813071009	F123	R13 RELIEF
60x60 cm 24"x24"	103071109	F116	R9 FLAT
	103071209	F117	R11 FLAT
	103071009	F117	R13 RELIEF
90x90 cm 36"x36"	803071109	F120	R9 FLAT
	803071209	F121	R11 FLAT
	803071009	F121	R13 RELIEF

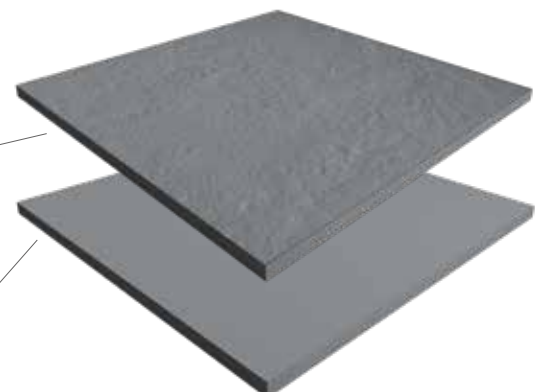

outdoor 20 mm & 30 mm

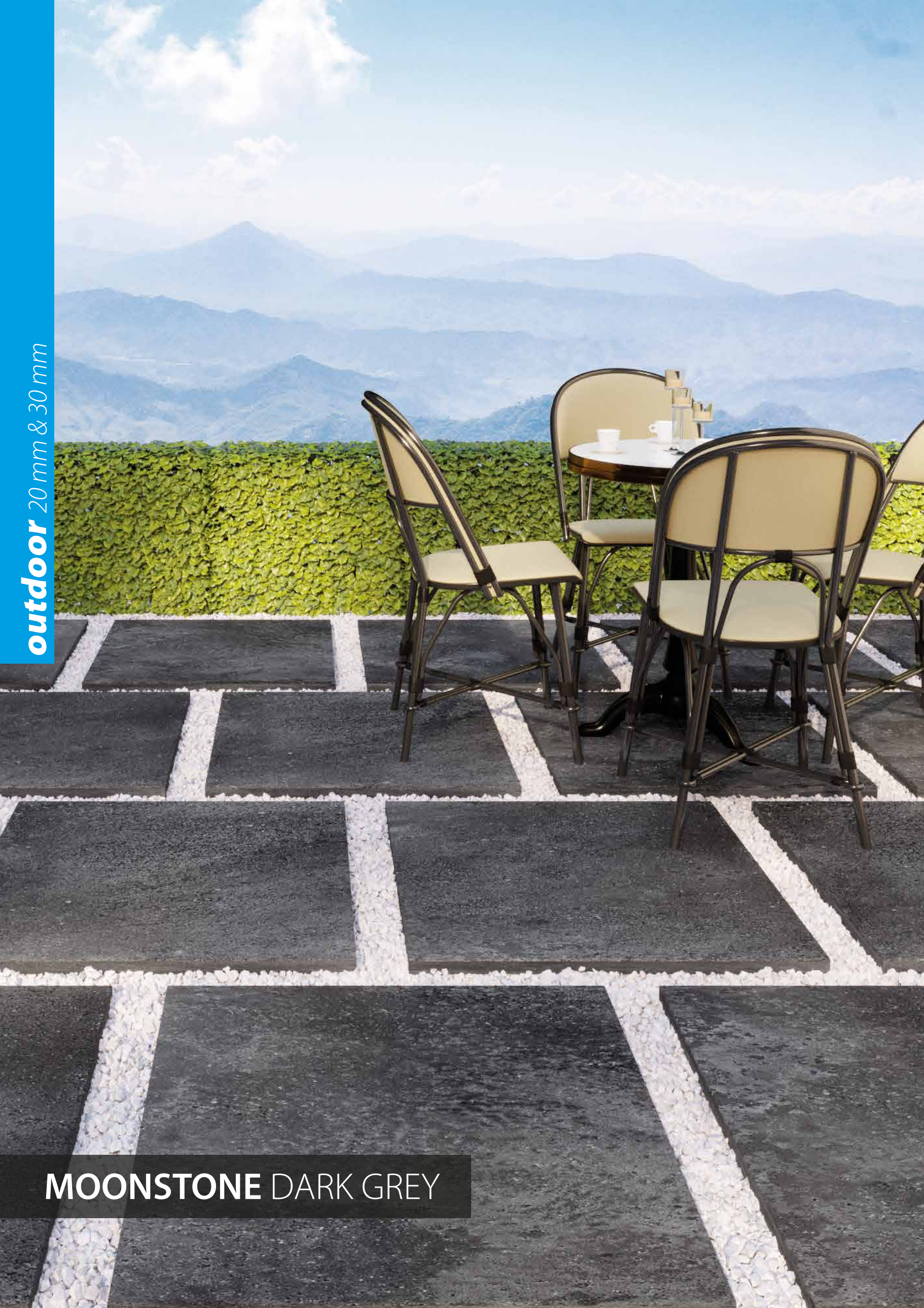

MOONSTONE DARK GREY

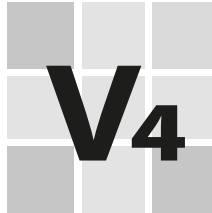
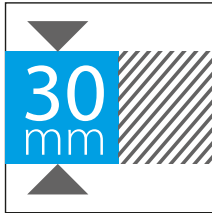

outdoor 20 mm & 30 mm

MOONSTONE DARK GREY



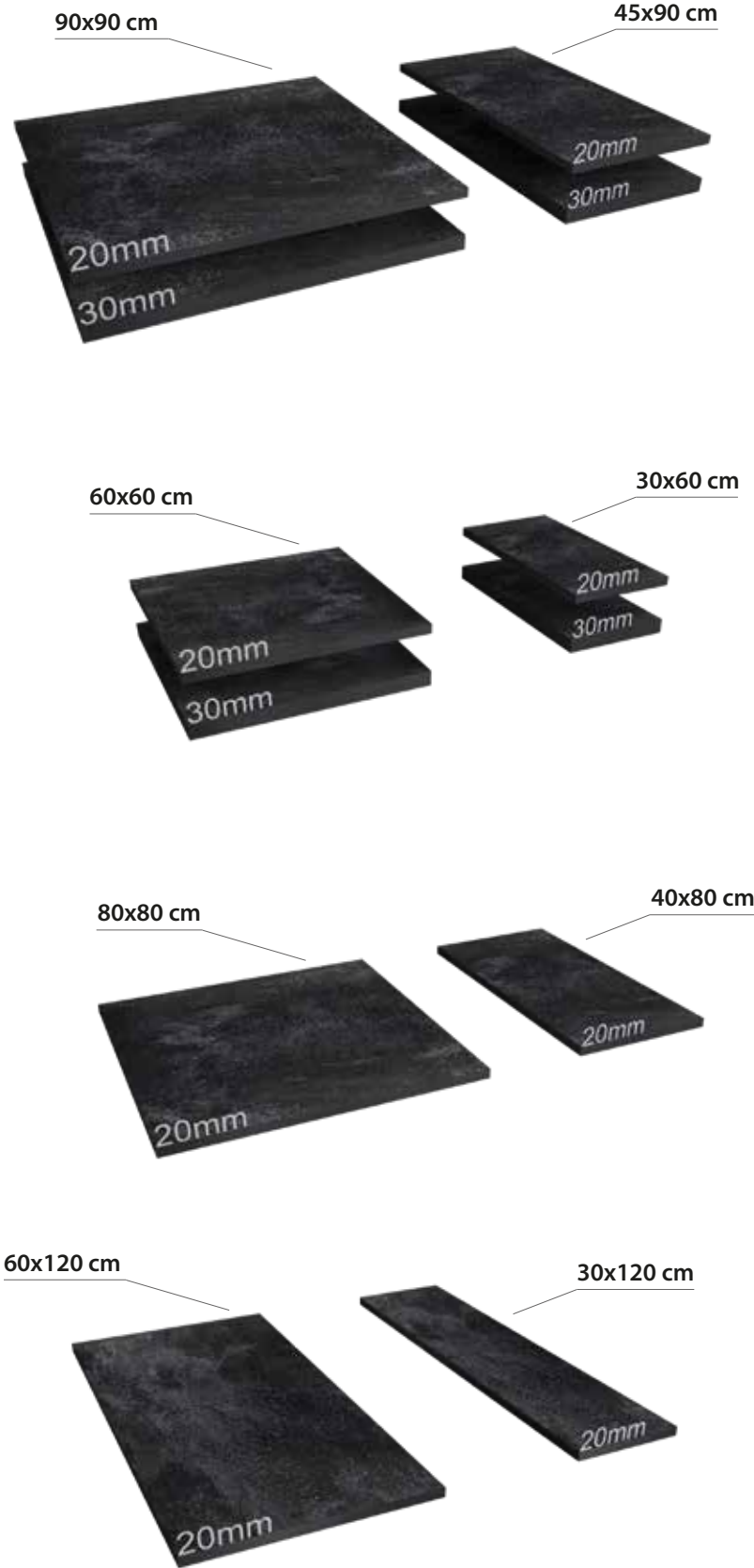

Kalınlık / Thickness: 20 mm

EBAT Sizes	ÜRÜN KODU Product Code	FIYAT Price Code	YÜZEY Surfaces
30x120 cm 12"x48"	312071513	F106	R9 FLAT
	312071613	F107	R11 FLAT
	312071413	F107	R13 RELIEF
30x60 cm 12"x24"	112071513	F108	R9 FLAT
	112071613	F109	R11 FLAT
	112071413	F109	R13 RELIEF
40x80 cm 16"x32"	712071513	F110	R9 FLAT
	712071613	F111	R11 FLAT
45x90 cm 18"x36"	812071513	F112	R9 FLAT
	812071613	F113	R11 FLAT
60x120 cm 24"x48"	302071513	F101	R9 FLAT
	302071613	F103	R11 FLAT
	302071413	F103	R13 RELIEF
60x60 cm 24"x24"	102071513	F100	R9 FLAT
	102071613	F102	R11 FLAT
	102071413	F102	R13 RELIEF
80x80 cm 32"x32"	702071513	F104	R9 FLAT
	702071613	F105	R11 FLAT
90x90 cm 36"x36"	802071513	F114	R9 FLAT
	802071613	F115	R11 FLAT

Kalınlık / Thickness: 30 mm

EBAT Sizes	ÜRÜN KODU Product Code	FIYAT Price Code	YÜZEY Surfaces
30x60 cm 12"x24"	113071513	F118	R9 FLAT
	113071613	F119	R11 FLAT
45x90 cm 18"x36"	813071513	F122	R9 FLAT
	813071613	F123	R11 FLAT
60x60 cm 24"x24"	103071513	F116	R9 FLAT
	103071613	F117	R11 FLAT
90x90 cm 36"x36"	803071513	F120	R9 FLAT
	803071613	F121	R11 FLAT

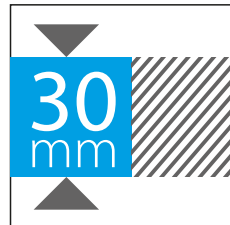
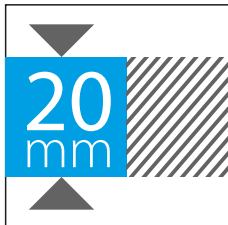

R13 - RELIEF

R9 - R11 - FLAT

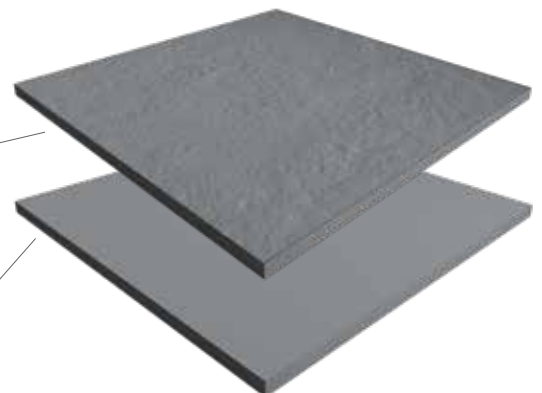



outdoor 20 mm & 30 mm

MOONSTONE GREY

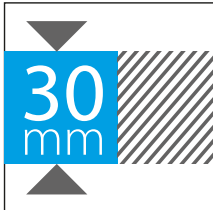
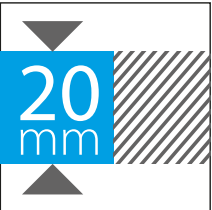

outdoor 20 mm & 30 mm

MOONSTONE GREY



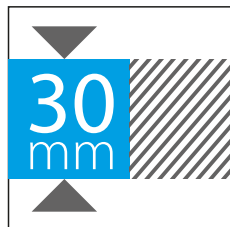
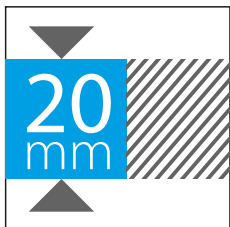
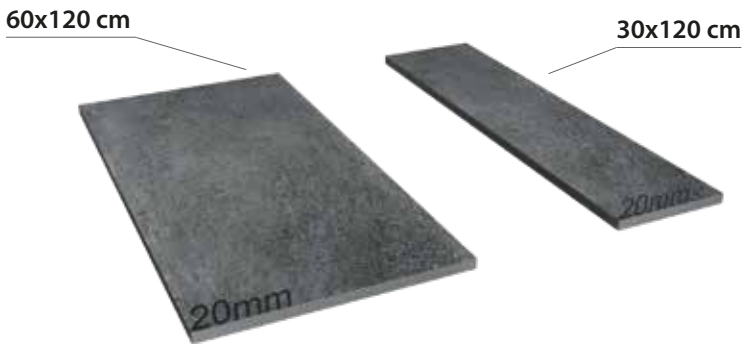
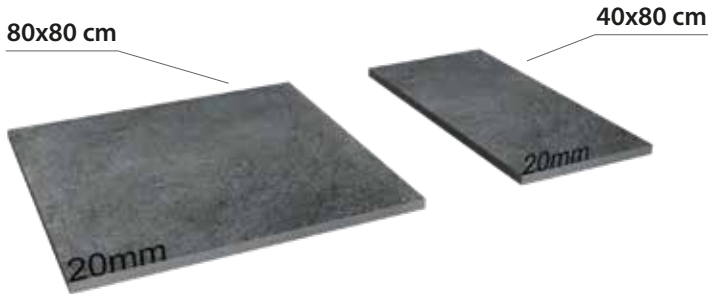
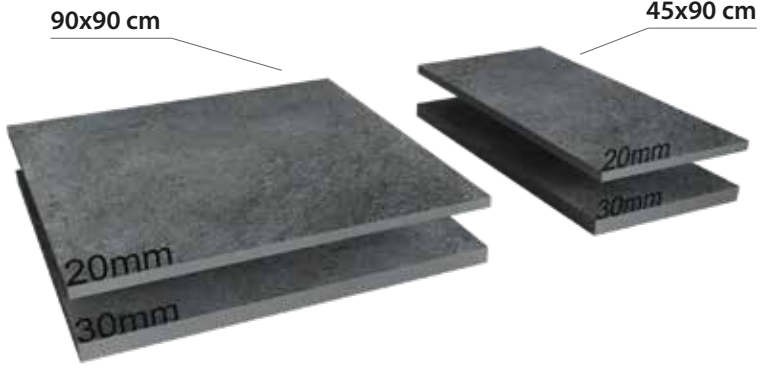

R13 - RELIEF

R9 - R11 - FLAT

Kalınlık / Thickness: 20 mm

EBAT Sizes	ÜRÜN KODU Product Code	FIYAT Price Code	YÜZEY Surfaces
30x120 cm 12"x48"	312071509	F106	R9 FLAT
	312071609	F107	R11 FLAT
	312071409	F107	R13 RELIEF
30x60 cm 12"x24"	112071509	F108	R9 FLAT
	112071609	F109	R11 FLAT
	112071409	F109	R13 RELIEF
40x80 cm 16"x32"	712071509	F110	R9 FLAT
	712071609	F111	R11 FLAT
45x90 cm 18"x36"	812071509	F112	R9 FLAT
	812071609	F113	R11 FLAT
60x120 cm 24"x48"	302071509	F101	R9 FLAT
	302071609	F103	R11 FLAT
	302071409	F103	R13 RELIEF
60x60 cm 24"x24"	102071509	F100	R9 FLAT
	102071609	F102	R11 FLAT
	102071409	F102	R13 RELIEF
80x80 cm 32"x32"	702071509	F104	R9 FLAT
	702071609	F105	R11 FLAT
90x90 cm 36"x36"	802071509	F114	R9 FLAT
	802071609	F115	R11 FLAT

Kalınlık / Thickness: 30 mm

EBAT Sizes	ÜRÜN KODU Product Code	FIYAT Price Code	YÜZEY Surfaces
30x60 cm 12"x24"	113071509	F118	R9 FLAT
	113071609	F119	R11 FLAT
45x90 cm 18"x36"	813071509	F122	R9 FLAT
	813071609	F123	R11 FLAT
60x60 cm 24"x24"	103071509	F116	R9 FLAT
	103071609	F117	R11 FLAT
90x90 cm 36"x36"	803071509	F120	R9 FLAT
	803071609	F121	R11 FLAT

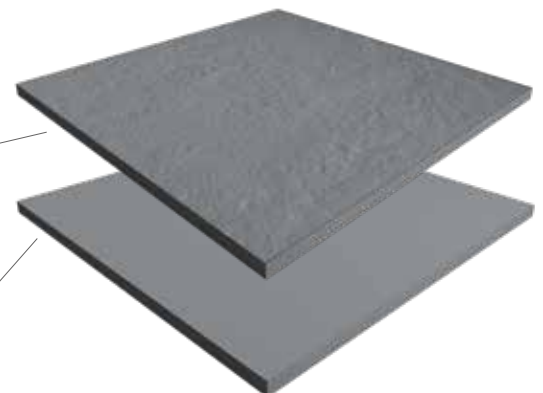

outdoor 20 mm & 30 mm



PIETROSA MARBLE

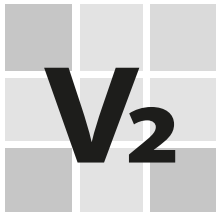
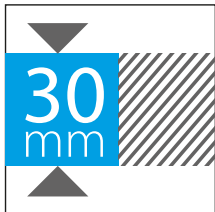
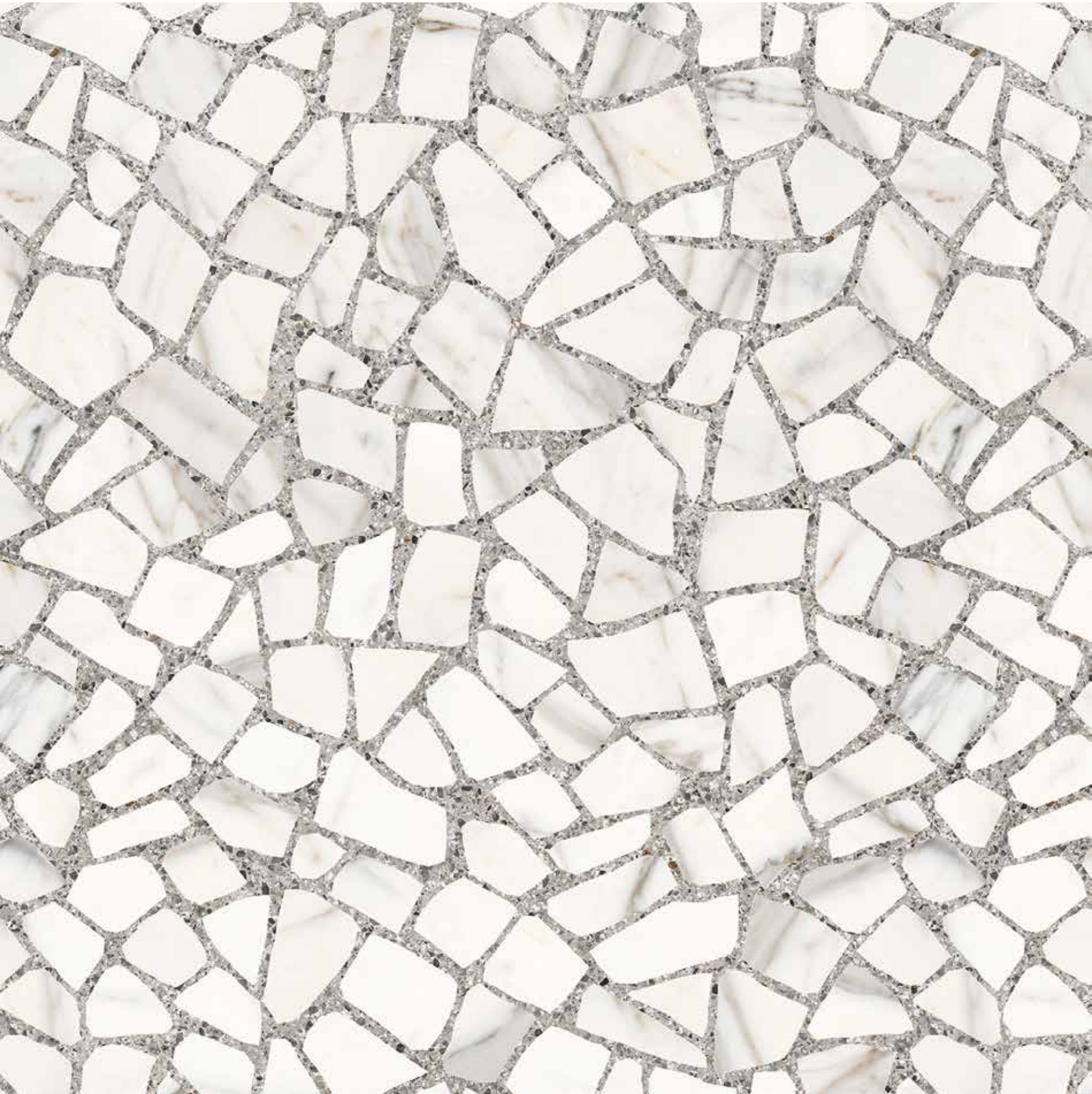

outdoor 20 mm & 30 mm



PIETROSA MARBLE

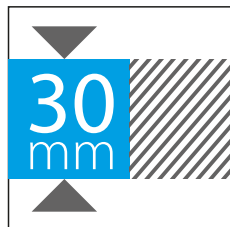
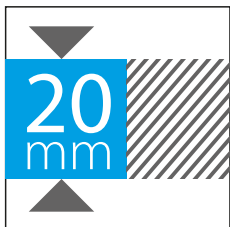
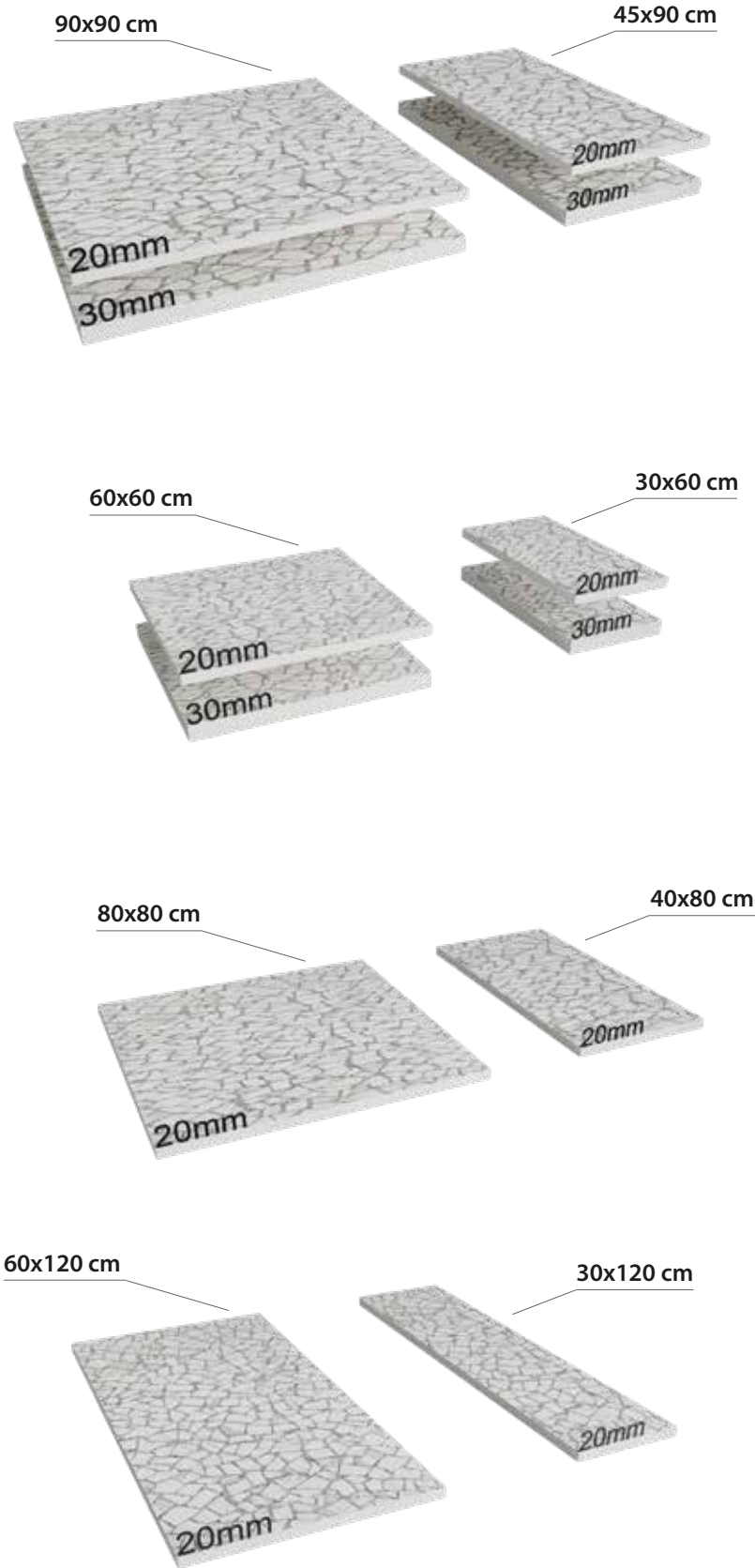

Kalınlık / Thickness: 20 mm

EBAT Sizes	ÜRÜN KODU Product Code	FIYAT Price Code	YÜZEY Surfaces
30x120 cm 12"x48"	312062800	F106	R9 FLAT
	312067300	F107	R11 FLAT
	312068800	F107	R13 RELIEF
30x60 cm 12"x24"	112062800	F108	R9 FLAT
	112067300	F109	R11 FLAT
	112068800	F109	R13 RELIEF
40x80 cm 16"x32"	712062800	F110	R9 FLAT
	712067300	F111	R11 FLAT
45x90 cm 18"x36"	812062800	F112	R9 FLAT
	812067300	F113	R11 FLAT
60x120 cm 24"x48"	302062800	F101	R9 FLAT
	302067300	F103	R11 FLAT
	302068800	F103	R13 RELIEF
60x60 cm 24"x24"	102062800	F100	R9 FLAT
	102067300	F102	R11 FLAT
	102068800	F102	R13 RELIEF
80x80 cm 32"x32"	702062800	F104	R9 FLAT
	702067300	F105	R11 FLAT
90x90 cm 36"x36"	802062800	F114	R9 FLAT
	802067300	F115	R11 FLAT

Kalınlık / Thickness: 30 mm

EBAT Sizes	ÜRÜN KODU Product Code	FIYAT Price Code	YÜZEY Surfaces
30x60 cm 12"x24"	113062800	F118	R9 FLAT
	113067300	F119	R11 FLAT
45x90 cm 18"x36"	813062800	F122	R9 FLAT
	813067300	F123	R11 FLAT
60x60 cm 24"x24"	103062800	F116	R9 FLAT
	103067300	F117	R11 FLAT
90x90 cm 36"x36"	803062800	F120	R9 FLAT
	803067300	F121	R11 FLAT

R13 - RELIEF

R9 - R11 - FLAT

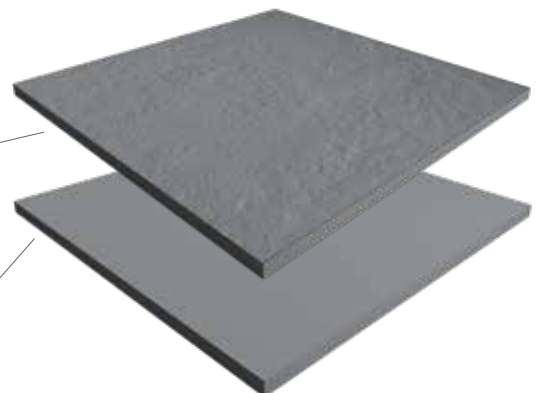



outdoor 20 mm & 30 mm

PIETROSA SAND

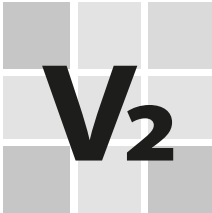
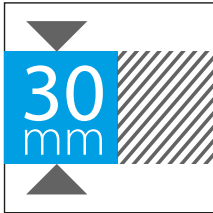

outdoor 20 mm & 30 mm

PIETROSA SAND

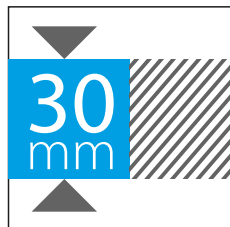
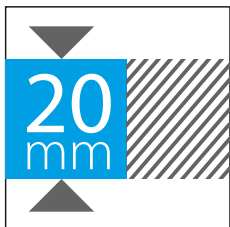
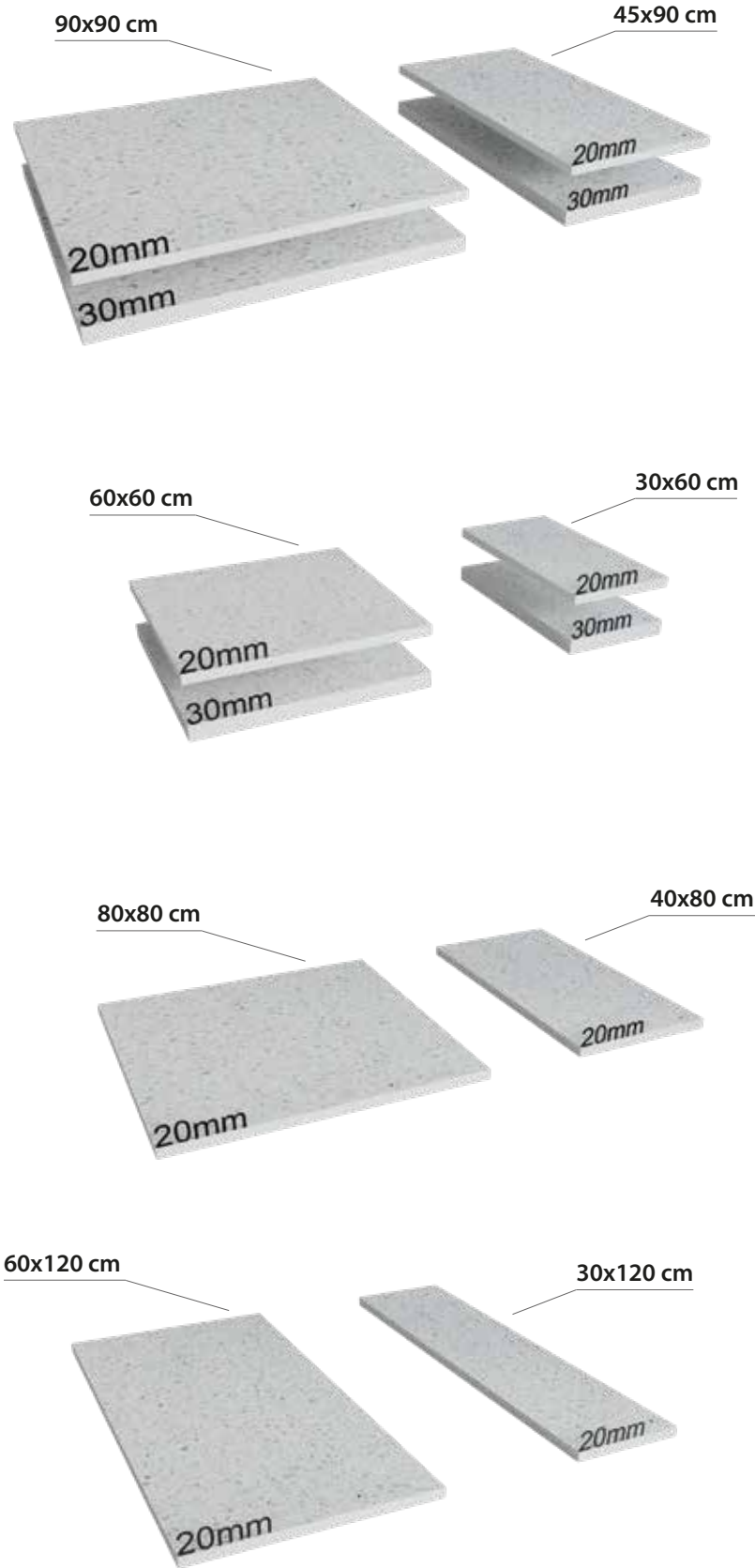

Kalınlık / Thickness: 20 mm

EBAT Sizes	ÜRÜN KODU Product Code	FIYAT Price Code	YÜZEY Surfaces
30x120 cm 12"x48"	312062858	F106	R9 FLAT
	312067358	F107	R11 FLAT
	312068858	F107	R13 RELIEF
30x60 cm 12"x24"	112062858	F108	R9 FLAT
	112067358	F109	R11 FLAT
	112068858	F109	R13 RELIEF
40x80 cm 16"x32"	712062858	F110	R9 FLAT
	712067358	F111	R11 FLAT
45x90 cm 18"x36"	812062858	F112	R9 FLAT
	812067358	F113	R11 FLAT
60x120 cm 24"x48"	302062858	F101	R9 FLAT
	302067358	F103	R11 FLAT
	302068858	F103	R13 RELIEF
60x60 cm 24"x24"	102062858	F100	R9 FLAT
	102067358	F102	R11 FLAT
	102068858	F102	R13 RELIEF
80x80 cm 32"x32"	702062858	F104	R9 FLAT
	702067358	F105	R11 FLAT
90x90 cm 36"x36"	802062858	F114	R9 FLAT
	802067358	F115	R11 FLAT

Kalınlık / Thickness: 30 mm

EBAT Sizes	ÜRÜN KODU Product Code	FIYAT Price Code	YÜZEY Surfaces
30x60 cm 12"x24"	113062858	F118	R9 FLAT
	113067358	F119	R11 FLAT
45x90 cm 18"x36"	813062858	F122	R9 FLAT
	813067358	F123	R11 FLAT
60x60 cm 24"x24"	103062858	F116	R9 FLAT
	103067358	F117	R11 FLAT
90x90 cm 36"x36"	803062858	F120	R9 FLAT
	803067358	F121	R11 FLAT

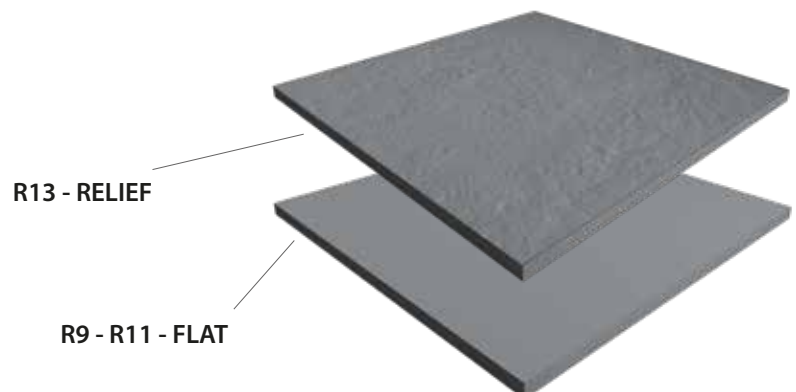



outdoor 20 mm & 30 mm

SANDSTORM WARM GREY

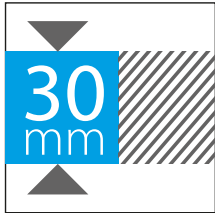



outdoor 20 mm & 30 mm

SANDSTORM WARM GREY



90x90 cm

45x90 cm



60x60 cm

30x60 cm



80x80 cm

40x80 cm

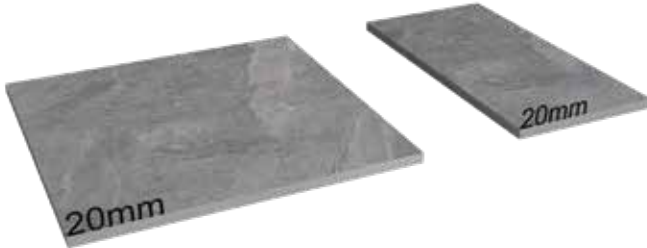

60x120 cm

30x120 cm

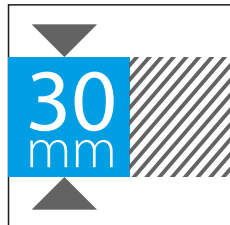
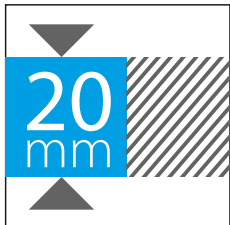
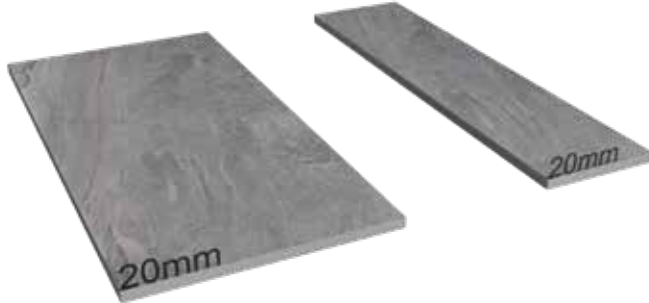

Kalınlık / Thickness: 20 mm

EBAT Sizes	ÜRÜN KODU Product Code	FIYAT Price Code	YÜZEY Surfaces
30x120 cm 12"x48"	312055423	F106	R9 FLAT
	312069223	F107	R11 FLAT
	312069123	F107	R13 RELIEF
30x60 cm 12"x24"	112055423	F108	R9 FLAT
	112069223	F109	R11 FLAT
	112069123	F109	R13 RELIEF
40x80 cm 16"x32"	712055423	F110	R9 FLAT
	712069223	F111	R11 FLAT
45x90 cm 18"x36"	812055423	F112	R9 FLAT
	812069223	F113	R11 FLAT
60x120 cm 24"x48"	302055423	F101	R9 FLAT
	302069223	F103	R11 FLAT
	302069123	F103	R13 RELIEF
60x60 cm 24"x24"	102055423	F100	R9 FLAT
	102069223	F102	R11 FLAT
	102069123	F102	R13 RELIEF
80x80 cm 32"x32"	702055423	F104	R9 FLAT
	702069223	F105	R11 FLAT
90x90 cm 36"x36"	802055423	F114	R9 FLAT
	802069223	F115	R11 FLAT

Kalınlık / Thickness: 30 mm

EBAT Sizes	ÜRÜN KODU Product Code	FIYAT Price Code	YÜZEY Surfaces
30x60 cm 12"x24"	113055423	F118	R9 FLAT
	113069223	F119	R11 FLAT
45x90 cm 18"x36"	813055423	F122	R9 FLAT
	813069223	F123	R11 FLAT
60x60 cm 24"x24"	103055423	F116	R9 FLAT
	103069223	F117	R11 FLAT
90x90 cm 36"x36"	803055423	F120	R9 FLAT
	803069223	F121	R11 FLAT

R13 - RELIEF

R9 - R11 - FLAT

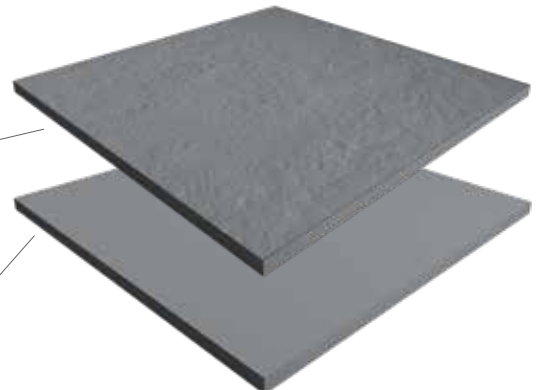

outdoor 20 mm & 30 mm

SAWNSTONE ANTRACITA



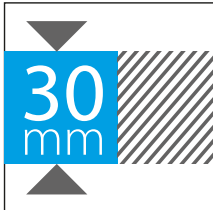
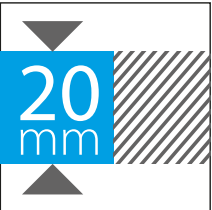

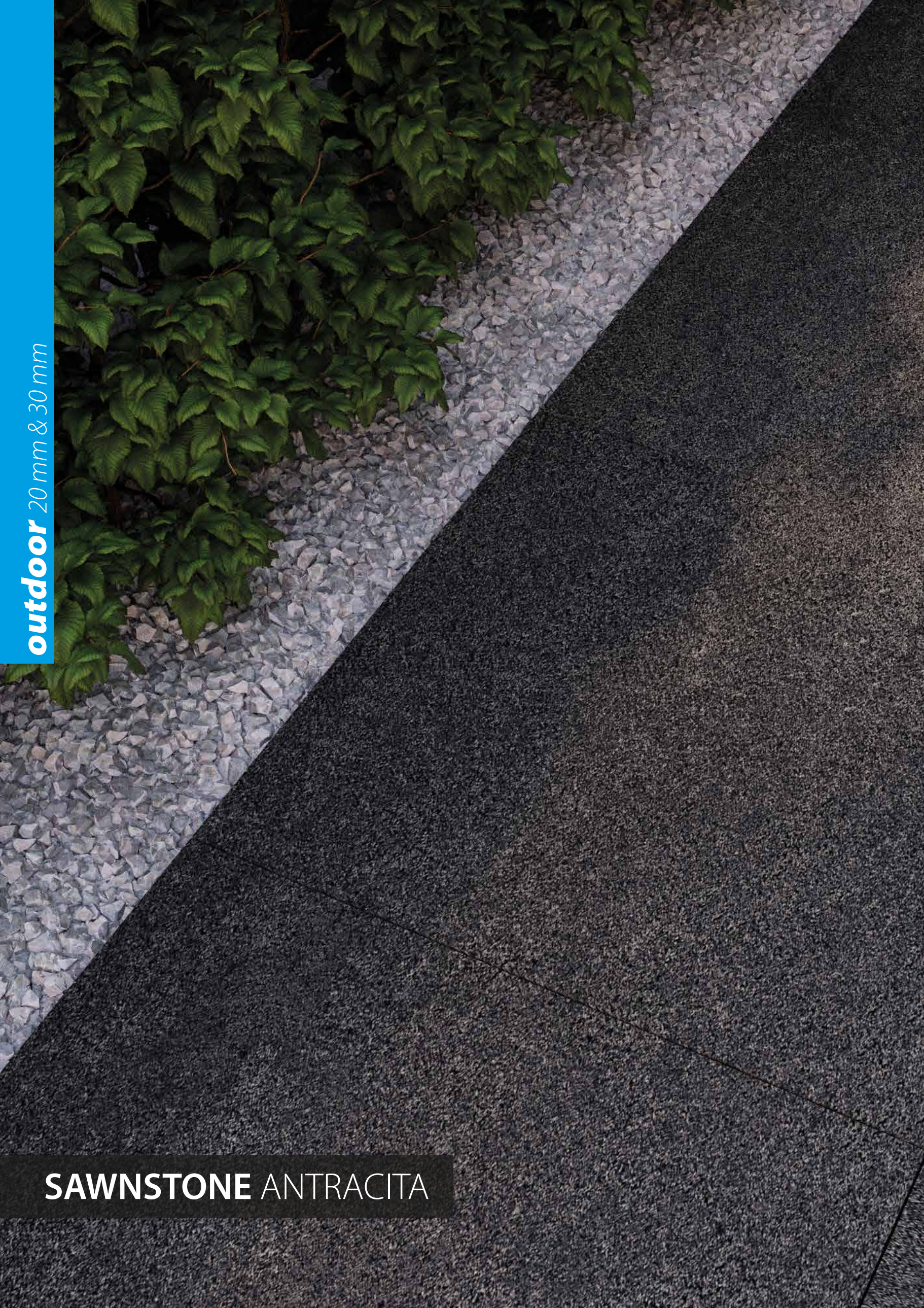

outdoor 20 mm & 30 mm

SAWNSTONE ANTRACITA

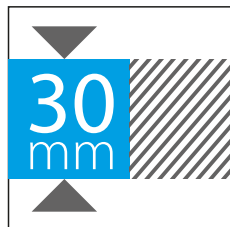
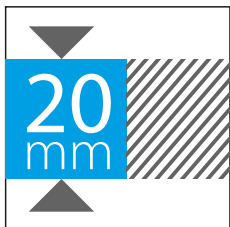
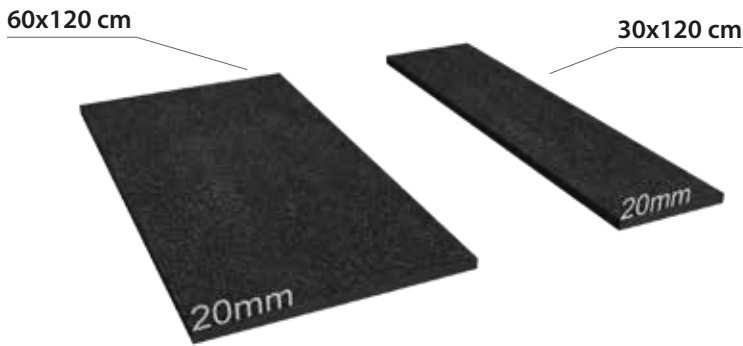
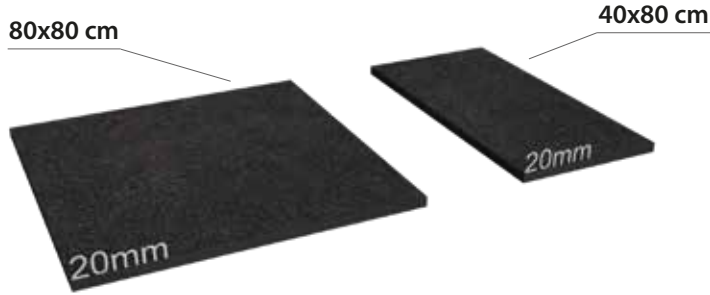
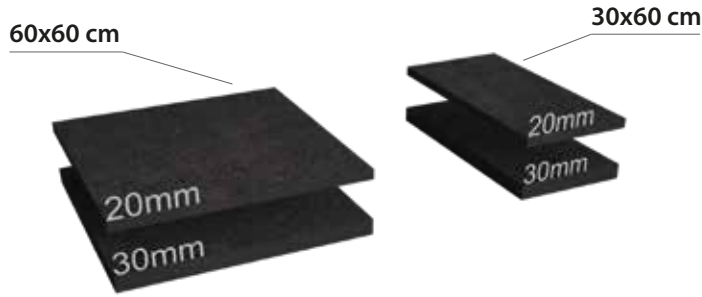
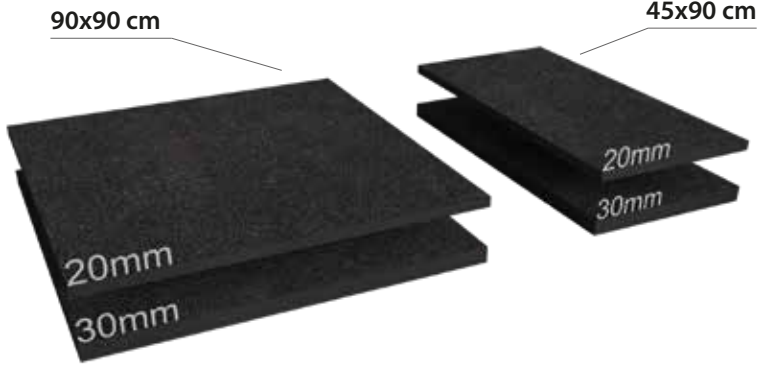

Kalınlık / Thickness: 20 mm

EBAT Sizes	ÜRÜN KODU Product Code	FIYAT Price Code	YÜZEY Surfaces
30x120 cm 12"x48"	312071968	F106	R9 FLAT
	312072068	F107	R11 FLAT
	312071868	F107	R13 RELIEF
30x60 cm 12"x24"	112071968	F108	R9 FLAT
	112072068	F109	R11 FLAT
	112071868	F109	R13 RELIEF
40x80 cm 16"x32"	712071968	F110	R9 FLAT
	712072068	F111	R11 FLAT
45x90 cm 18"x36"	812071968	F112	R9 FLAT
	812072068	F113	R11 FLAT
60x120 cm 24"x48"	302071968	F101	R9 FLAT
	302072068	F103	R11 FLAT
	302071868	F103	R13 RELIEF
60x60 cm 24"x24"	102071968	F100	R9 FLAT
	102072068	F102	R11 FLAT
	102071868	F102	R13 RELIEF
80x80 cm 32"x32"	702071968	F104	R9 FLAT
	702072068	F105	R11 FLAT
90x90 cm 36"x36"	802071968	F114	R9 FLAT
	802072068	F115	R11 FLAT

Kalınlık / Thickness: 30 mm

EBAT Sizes	ÜRÜN KODU Product Code	FIYAT Price Code	YÜZEY Surfaces
30x60 cm 12"x24"	113071968	F118	R9 FLAT
	113072068	F119	R11 FLAT
	113071868	F119	R13 RELIEF
45x90 cm 18"x36"	813071968	F122	R9 FLAT
	813072068	F123	R11 FLAT
	813071868	F123	R13 RELIEF
60x60 cm 24"x24"	103071968	F116	R9 FLAT
	103072068	F117	R11 FLAT
	103071868	F117	R13 RELIEF
90x90 cm 36"x36"	803071968	F120	R9 FLAT
	803072068	F121	R11 FLAT
	803071868	F121	R13 RELIEF

R13 - RELIEF

R9 - R11 - FLAT

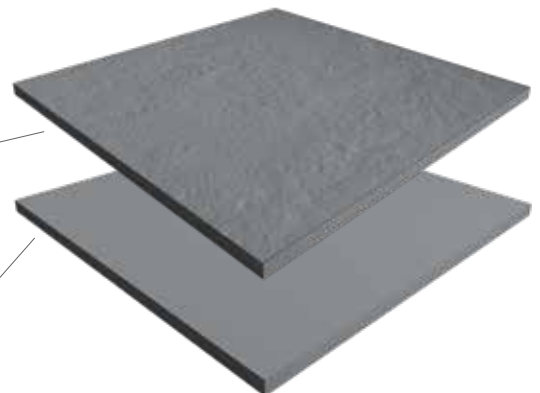

outdoor 20 mm & 30 mm



SAWNSTONE GREY

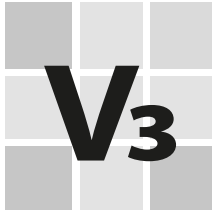
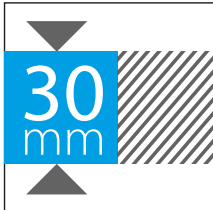
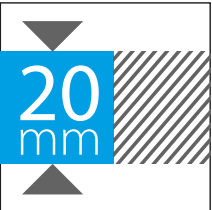
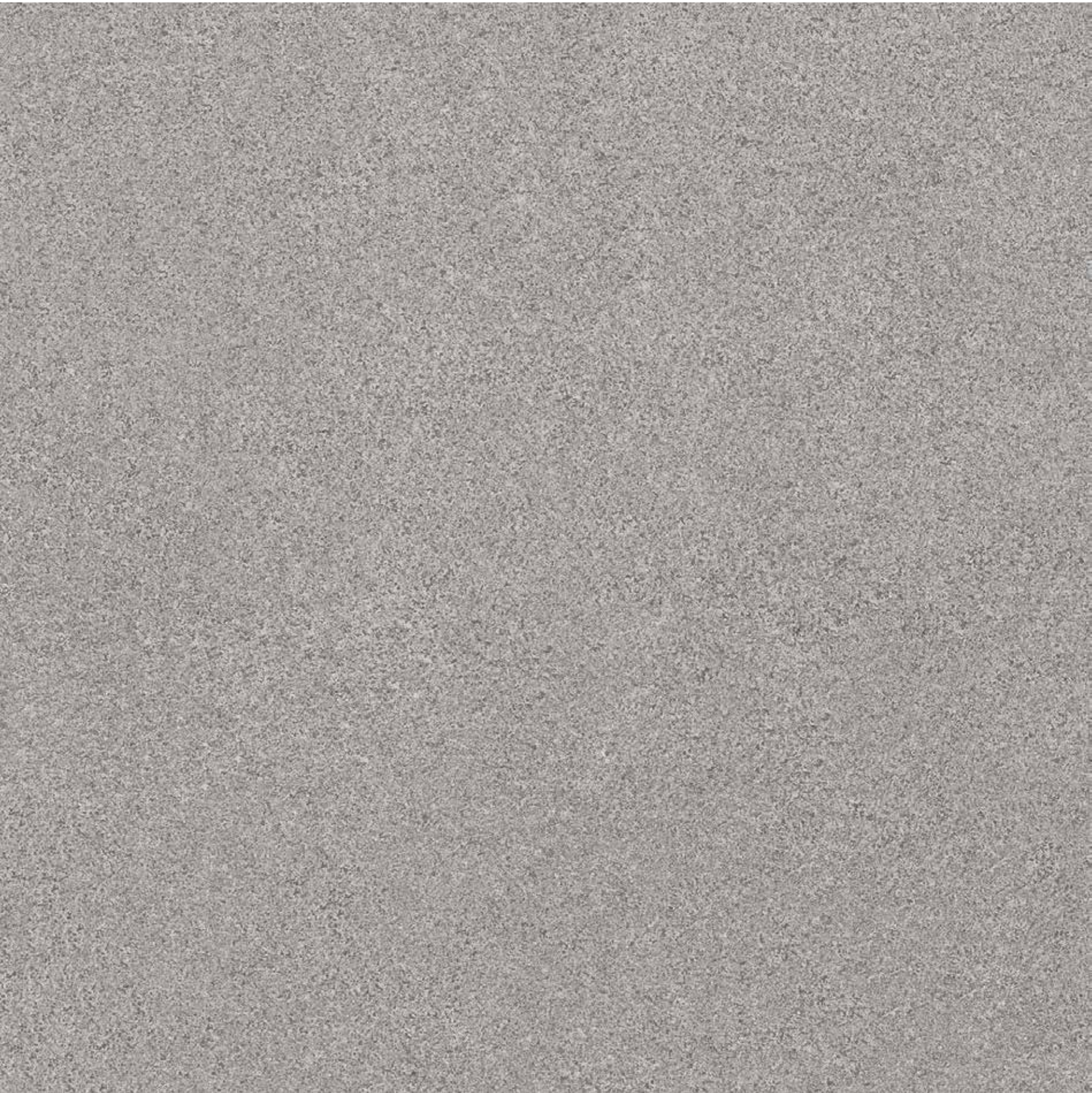

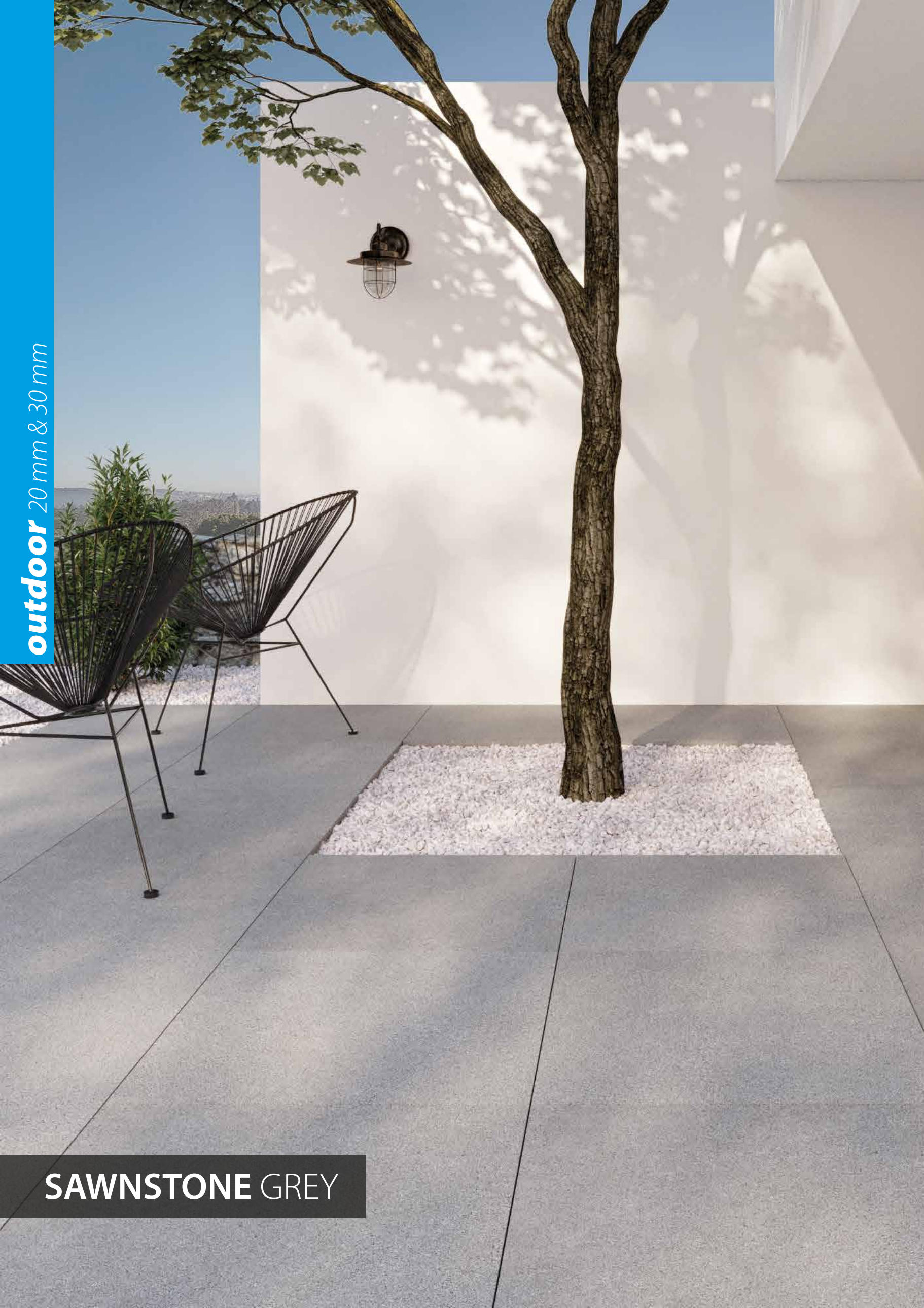

outdoor 20 mm & 30 mm

SAWNSTONE GREY

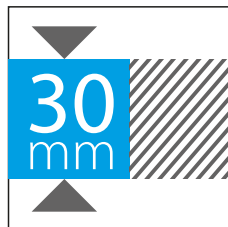
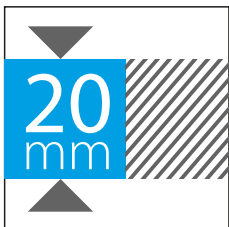
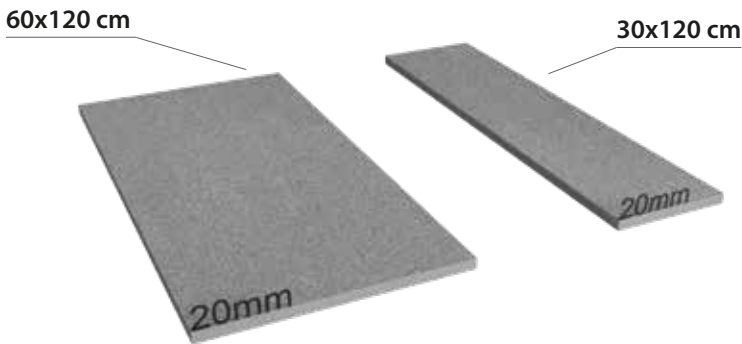
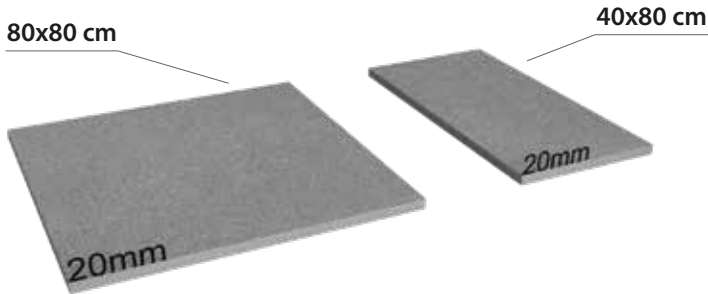
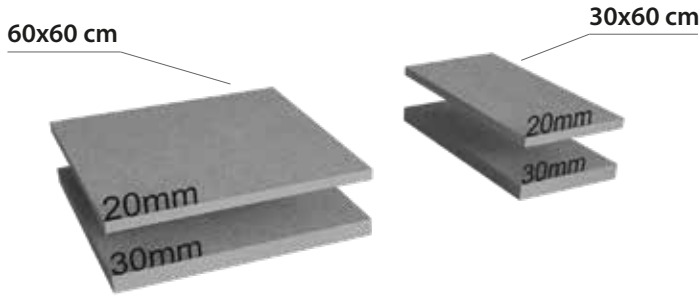
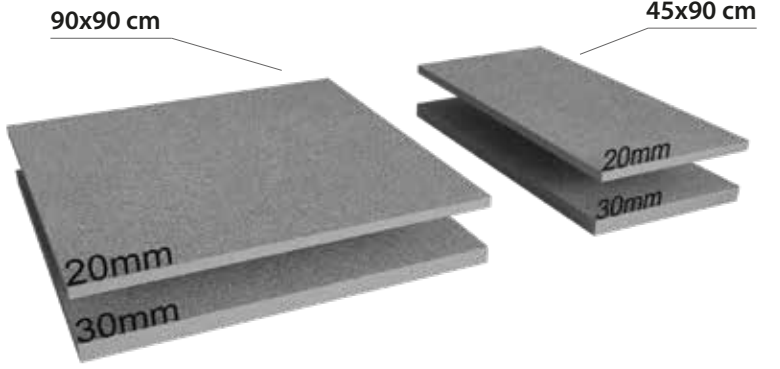

Kalınlık / Thickness: 20 mm

EBAT Sizes	ÜRÜN KODU Product Code	FIYAT Price Code	YÜZEY Surfaces
30x120 cm 12"x48"	312071909	F106	R9 FLAT
	312072009	F107	R11 FLAT
	312071809	F107	R13 RELIEF
30x60 cm 12"x24"	112071909	F108	R9 FLAT
	112072009	F109	R11 FLAT
	112071809	F109	R13 RELIEF
40x80 cm 16"x32"	712071909	F110	R9 FLAT
	712072009	F111	R11 FLAT
45x90 cm 18"x36"	812071909	F112	R9 FLAT
	812072009	F113	R11 FLAT
60x120 cm 24"x48"	302071909	F101	R9 FLAT
	302072009	F103	R11 FLAT
	302071809	F103	R13 RELIEF
60x60 cm 24"x24"	102071909	F100	R9 FLAT
	102072009	F102	R11 FLAT
	102071809	F102	R13 RELIEF
80x80 cm 32"x32"	702071909	F104	R9 FLAT
	702072009	F105	R11 FLAT
90x90 cm 36"x36"	802071909	F114	R9 FLAT
	802072009	F115	R11 FLAT

Kalınlık / Thickness: 30 mm

EBAT Sizes	ÜRÜN KODU Product Code	FIYAT Price Code	YÜZEY Surfaces
30x60 cm 12"x24"	113071909	F118	R9 FLAT
	113072009	F119	R11 FLAT
	113071809	F119	R13 RELIEF
45x90 cm 18"x36"	813071909	F122	R9 FLAT
	813072009	F123	R11 FLAT
	813071809	F123	R13 RELIEF
60x60 cm 24"x24"	103071909	F116	R9 FLAT
	103072009	F117	R11 FLAT
	103071809	F117	R13 RELIEF
90x90 cm 36"x36"	803071909	F120	R9 FLAT
	803072009	F121	R11 FLAT
	803071809	F121	R13 RELIEF

R13 - RELIEF

R9 - R11 - FLAT

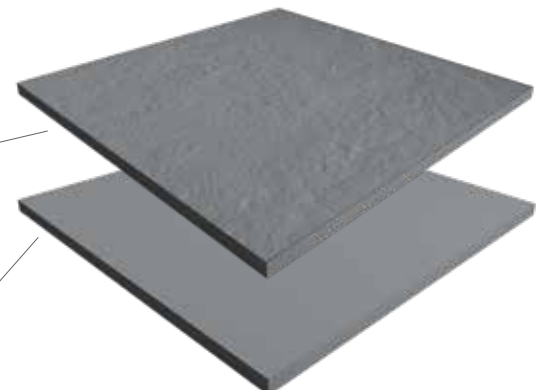

outdoor 20 mm & 30 mm



SUDBURY ANTRACITA

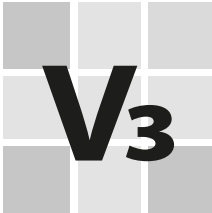
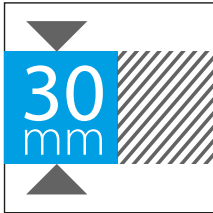

outdoor 20 mm & 30 mm

SUDBURY ANTRACITA



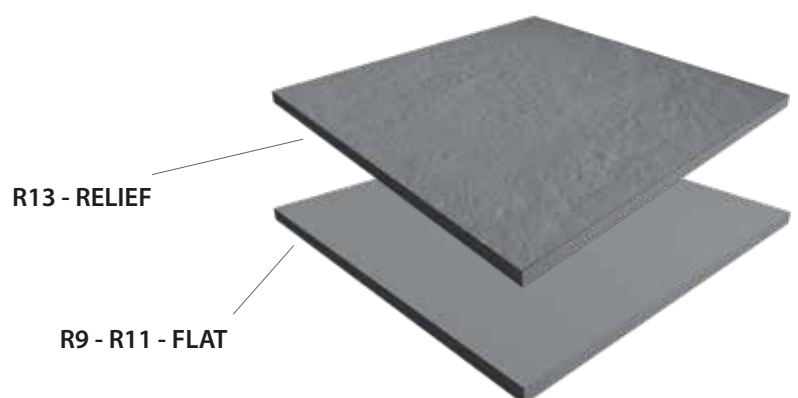
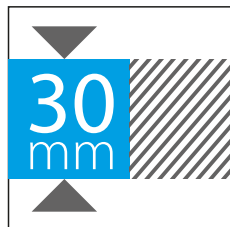
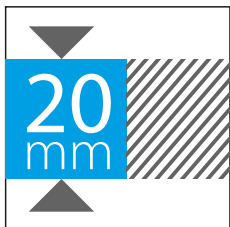
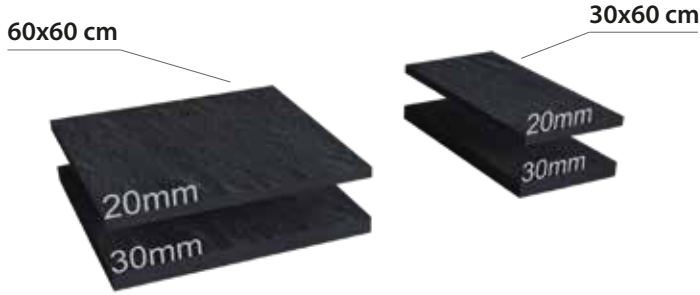

Kalınlık / Thickness: 20 mm

EBAT Sizes	ÜRÜN KODU Product Code	FIYAT Price Code	YÜZEY Surfaces
30x120 cm 12"x48"	312072368	F106	R9 FLAT
	312072468	F107	R11 FLAT
	312072268	F107	R13 RELIEF
30x60 cm 12"x24"	112072368	F108	R9 FLAT
	112072468	F109	R11 FLAT
	112072268	F109	R13 RELIEF
40x80 cm 16"x32"	712072368	F110	R9 FLAT
	712072468	F111	R11 FLAT
45x90 cm 18"x36"	812072368	F112	R9 FLAT
	812072468	F113	R11 FLAT
60x120 cm 24"x48"	302072368	F101	R9 FLAT
	302072468	F103	R11 FLAT
	302072268	F103	R13 RELIEF
60x60 cm 24"x24"	102072368	F100	R9 FLAT
	102072468	F102	R11 FLAT
	102072268	F102	R13 RELIEF
80x80 cm 32"x32"	702072368	F104	R9 FLAT
	702072468	F105	R11 FLAT
90x90 cm 36"x36"	802072368	F114	R9 FLAT
	802072468	F115	R11 FLAT

Kalınlık / Thickness: 30 mm

EBAT Sizes	ÜRÜN KODU Product Code	FIYAT Price Code	YÜZEY Surfaces
30x60 cm 12"x24"	113072368	F118	R9 FLAT
	113072468	F119	R11 FLAT
	113072268	F119	R13 RELIEF
45x90 cm 18"x36"	813072368	F122	R9 FLAT
	813072468	F123	R11 FLAT
	813072268	F123	R13 RELIEF
60x60 cm 24"x24"	103072368	F116	R9 FLAT
	103072468	F117	R11 FLAT
	103072268	F117	R13 RELIEF
90x90 cm 36"x36"	803072368	F120	R9 FLAT
	803072468	F121	R11 FLAT
	803072268	F121	R13 RELIEF

outdoor 20 mm & 30 mm



SUDBURY DARK GREY

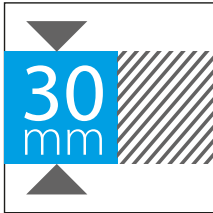
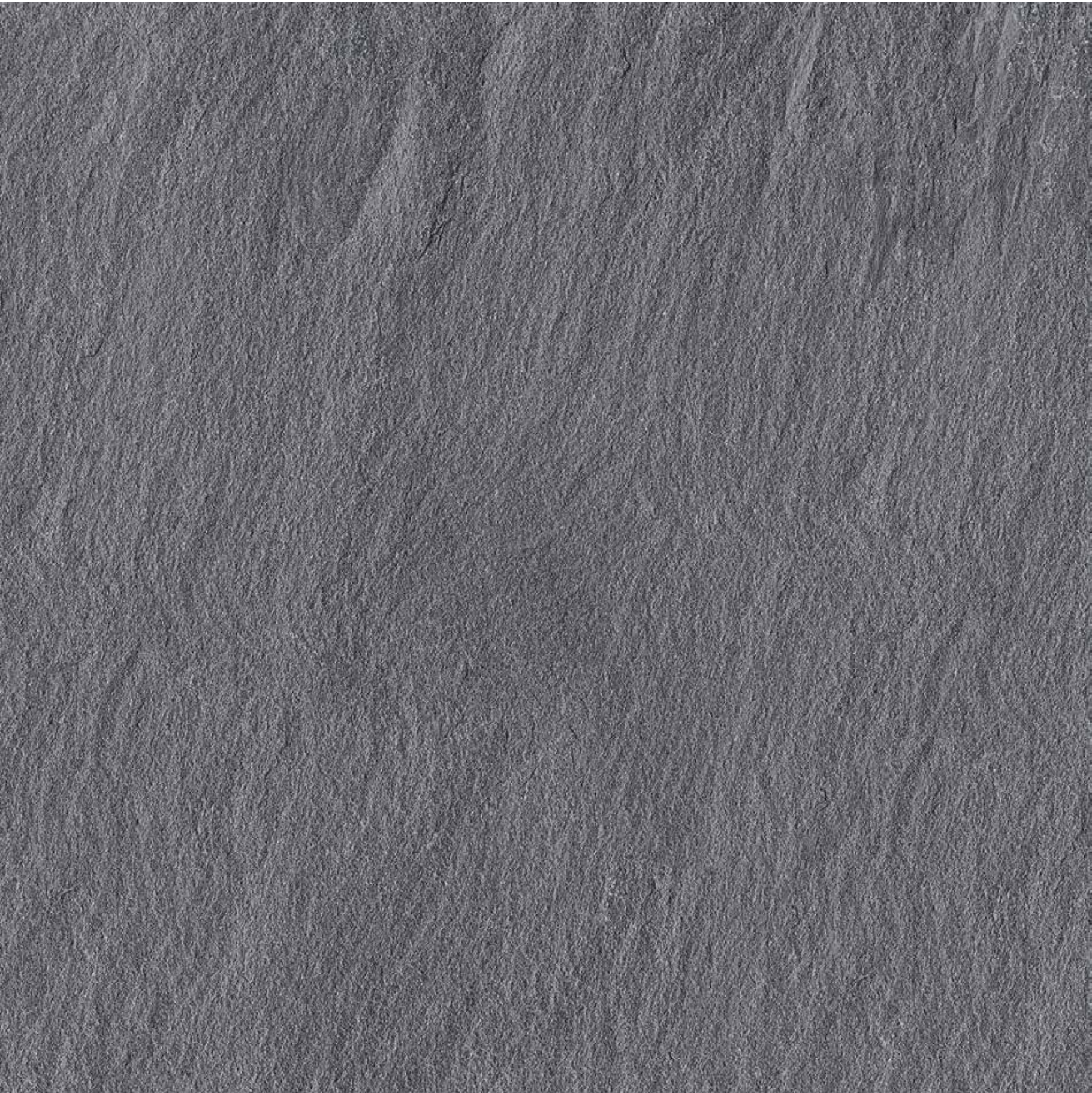

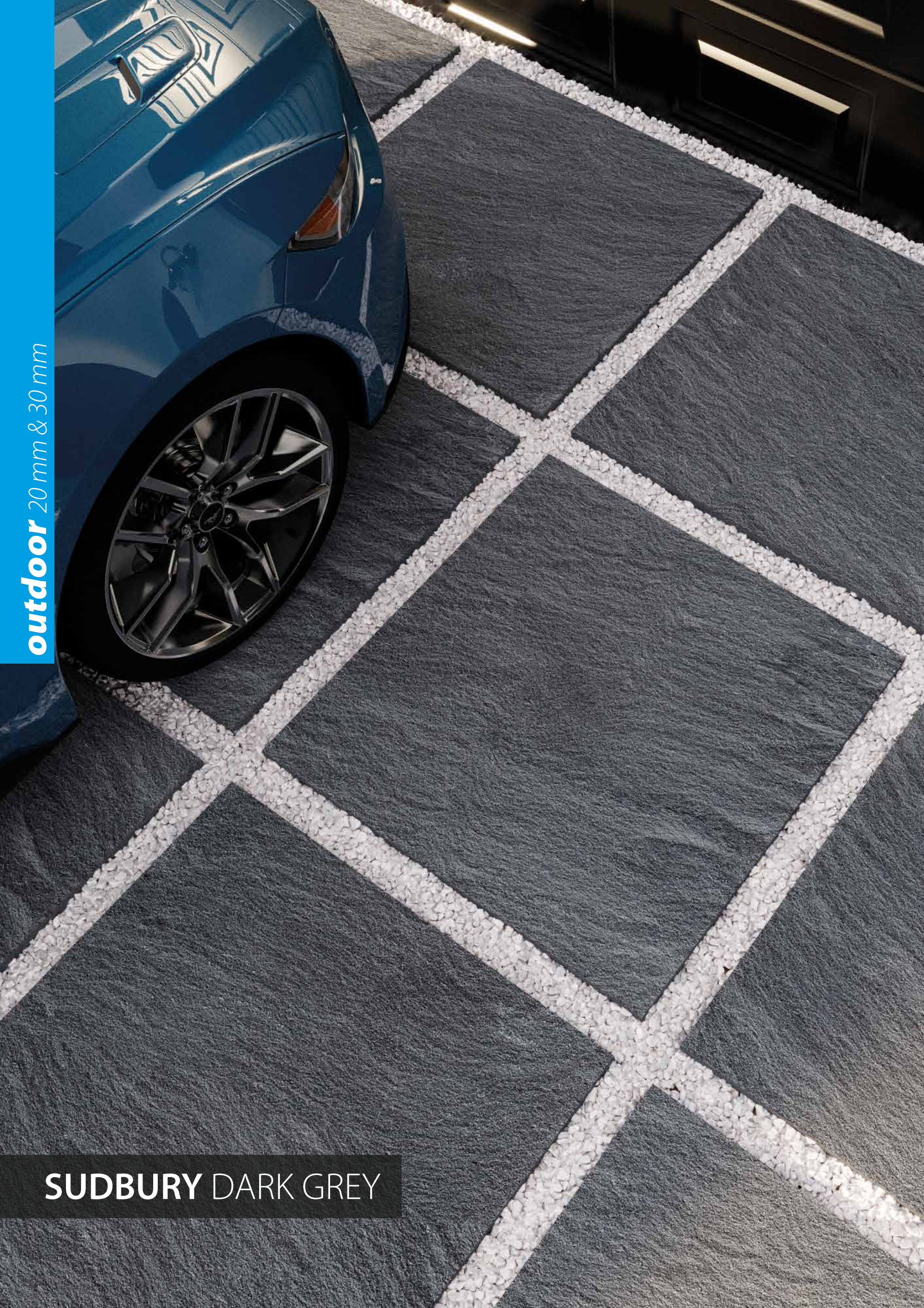

outdoor 20 mm & 30 mm

SUDBURY DARK GREY

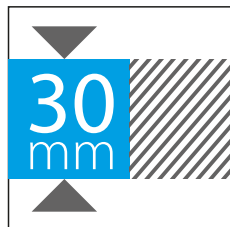
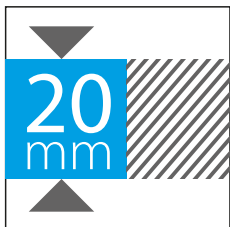
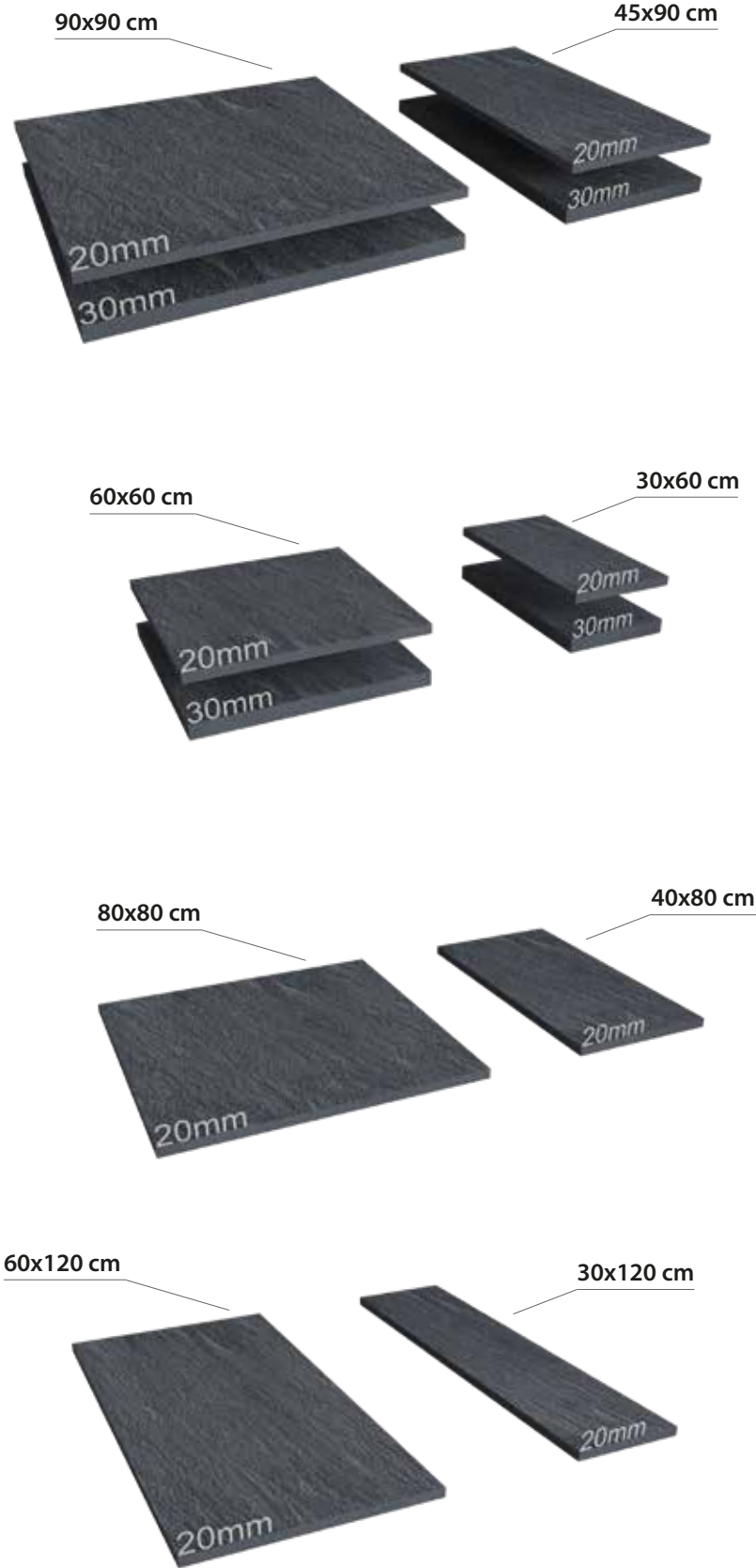

Kalınlık / Thickness: 20 mm

EBAT Sizes	ÜRÜN KODU Product Code	FIYAT Price Code	YÜZEY Surfaces
30x120 cm 12"x48"	312072313	F106	R9 FLAT
	312072413	F107	R11 FLAT
	312072213	F107	R13 RELIEF
30x60 cm 12"x24"	112072313	F108	R9 FLAT
	112072413	F109	R11 FLAT
	112072213	F109	R13 RELIEF
40x80 cm 16"x32"	712072313	F110	R9 FLAT
	712072413	F111	R11 FLAT
45x90 cm 18"x36"	812072313	F112	R9 FLAT
	812072413	F113	R11 FLAT
60x120 cm 24"x48"	302072313	F101	R9 FLAT
	302072413	F103	R11 FLAT
	302072213	F103	R13 RELIEF
60x60 cm 24"x24"	102072313	F100	R9 FLAT
	102072413	F102	R11 FLAT
	102072213	F102	R13 RELIEF
80x80 cm 32"x32"	702072313	F104	R9 FLAT
	702072413	F105	R11 FLAT
90x90 cm 36"x36"	802072313	F114	R9 FLAT
	802072413	F115	R11 FLAT

Kalınlık / Thickness: 30 mm

EBAT Sizes	ÜRÜN KODU Product Code	FIYAT Price Code	YÜZEY Surfaces
30x60 cm 12"x24"	113072313	F118	R9 FLAT
	113072413	F119	R11 FLAT
45x90 cm 18"x36"	813072313	F122	R9 FLAT
	813072413	F123	R11 FLAT
60x60 cm 24"x24"	103072313	F116	R9 FLAT
	103072413	F117	R11 FLAT
90x90 cm 36"x36"	803072313	F120	R9 FLAT
	803072413	F121	R11 FLAT

R13 - RELIEF

R9 - R11 - FLAT

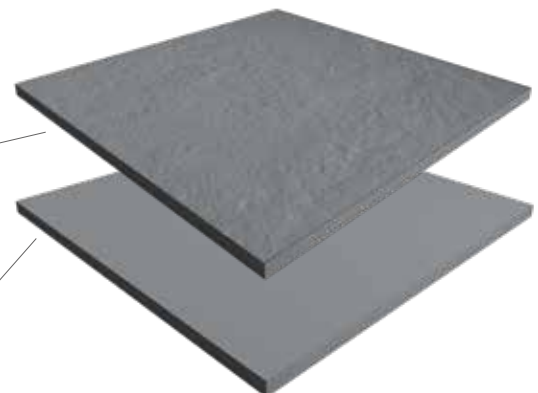



outdoor 20 mm & 30 mm

SUDBURY LIGHT GREY

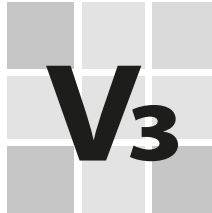
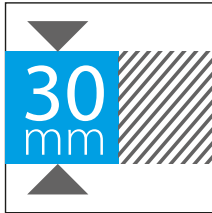



outdoor 20 mm & 30 mm

SUDBURY LIGHT GREY

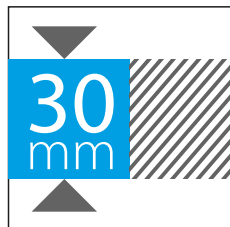
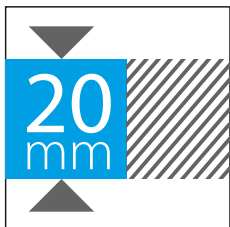
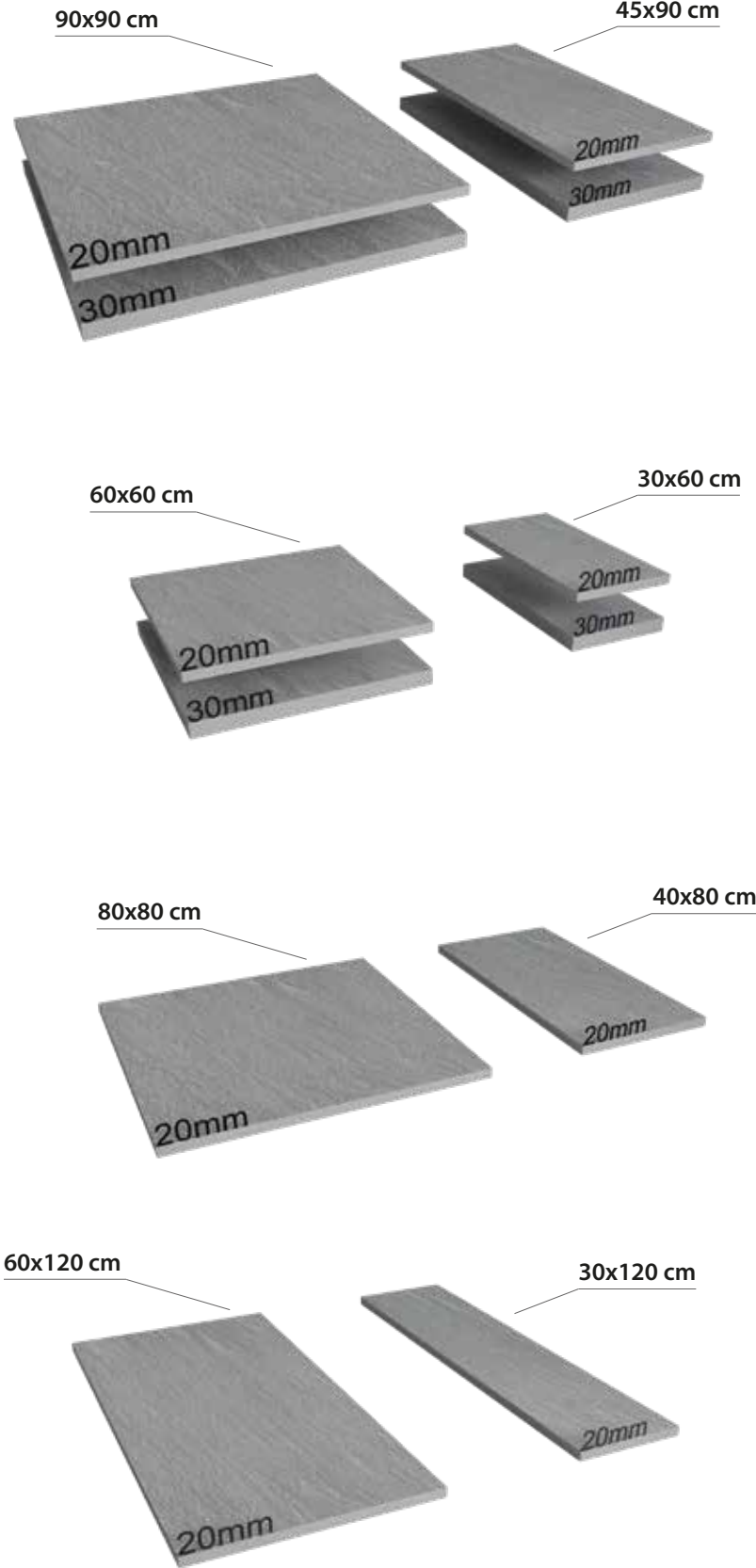

Kalınlık / Thickness: 20 mm

EBAT Sizes	ÜRÜN KODU Product Code	FIYAT Price Code	YÜZEY Surfaces
30x120 cm 12"x48"	312072338	F106	R9 FLAT
	312072438	F107	R11 FLAT
	312072238	F107	R13 RELIEF
30x60 cm 12"x24"	112072338	F108	R9 FLAT
	112072438	F109	R11 FLAT
	112072238	F109	R13 RELIEF
40x80 cm 16"x32"	712072338	F110	R9 FLAT
	712072438	F111	R11 FLAT
45x90 cm 18"x36"	812072338	F112	R9 FLAT
	812072438	F113	R11 FLAT
60x120 cm 24"x48"	302072338	F101	R9 FLAT
	302072438	F103	R11 FLAT
	302072238	F103	R13 RELIEF
60x60 cm 24"x24"	102072338	F100	R9 FLAT
	102072438	F102	R11 FLAT
	102072238	F102	R13 RELIEF
80x80 cm 32"x32"	702072338	F104	R9 FLAT
	702072438	F105	R11 FLAT
90x90 cm 36"x36"	802072338	F114	R9 FLAT
	802072438	F115	R11 FLAT

Kalınlık / Thickness: 30 mm

EBAT Sizes	ÜRÜN KODU Product Code	FIYAT Price Code	YÜZEY Surfaces
30x60 cm 12"x24"	113072338	F118	R9 FLAT
	113072438	F119	R11 FLAT
45x90 cm 18"x36"	813072338	F122	R9 FLAT
	813072438	F123	R11 FLAT
60x60 cm 24"x24"	103072338	F116	R9 FLAT
	103072438	F117	R11 FLAT
90x90 cm 36"x36"	803072338	F120	R9 FLAT
	803072438	F121	R11 FLAT

R13 - RELIEF

R9 - R11 - FLAT

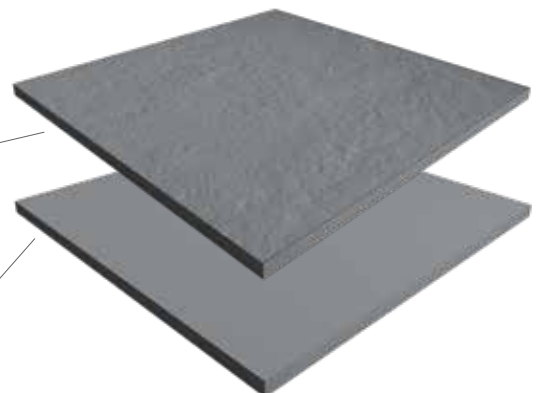



outdoor 20 mm & 30 mm

AUMA OAK



Kalınlık / Thickness: 20 mm

EBAT Sizes	ÜRÜN KODU Product Code	FİYAT Price Code	YÜZEY Surfaces
30x120 cm 12"x48"	312054470	F106	R9 FLAT

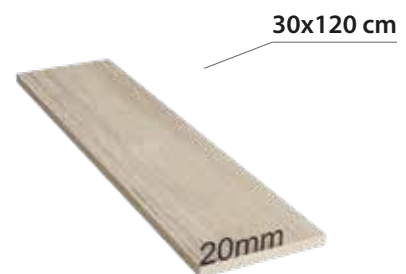
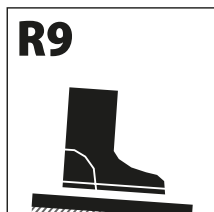

outdoor 20 mm & 30 mm

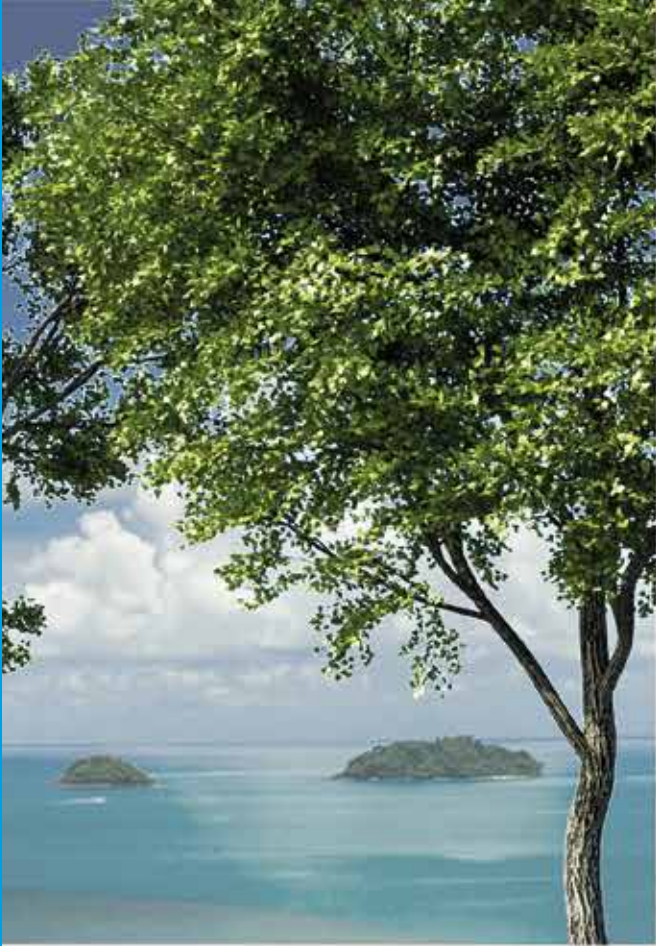

AUMA TAUPE



Kalınlık / Thickness: 20 mm

EBAT Sizes	ÜRÜN KODU Product Code	FİYAT Price Code	YÜZEY Surfaces
30x120 cm 12"x48"	312054491	F106	R9 FLAT

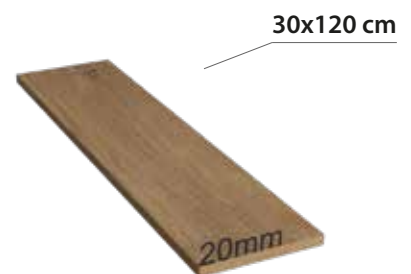
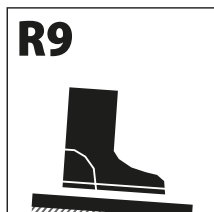

Application
solutions
for **20mm** products
30mm

ÇİMENLERE MONTAJ

*Laying
on lawn*

ÇAKIL VEYA KUM ÜZERİNE MONTAJ

*Laying on gravel
or sand*



Keşfedilecek yepyeni bir dünya var
There's a whole new world to be discovered

YAPIŞTIRICI İLE UYGULAMA

*Adhesive
installation*

YÜKSELTİLMİŞ AYAK SİSTEMİ ÜZERİNE KURULUM

*Installation on
raised pedestal
system*

outdoor 20 mm & 30 mm



ÇİMENLERE MONTAJ

Laying on lawn

Bahçede yürüyüş yolları, barbekü alanları ve çardaklar oluşturmak için ideal döşeme çözümü: zemine döşeme yaparak, altta yatan çimi koruyabilir, ağırlığın veya ağır yaya trafiğinin zarar görmesini önleyebilirsiniz. Seri, kamu ve konut yürüyüş yolları ve açık alanlar oluşturmak için de uygundur.

The ideal laying solution for creating walkways, barbecue areas and gazebos in the garden: by laying tile on the ground, you can preserve the underlying lawn, preventing it from being damaged by weights or heavy foot traffic. The range is also suitable for creating public and residential walkways and outdoor areas.



Çimen üzerine kurulum
Laying on lawn

outdoor 20 mm & 30 mm



ÇAKIL VEYA KUM ÜZERİNE MONTAJ

*Laying on gravel
or sand*

Çakıl döşemesi, zeminlerin drenajını sağlayarak, plakalar arasındaki boşluklardan geçerek suyun toprağa akmasını sağlar. Bu döşeme çözümü, kalıcı zemin döşemenin mümkün olmadığı projeler için idealdir.

Laying on gravel ensures correct soil drainage, through the gaps between the slabs, allowing the water to drain off into the ground. This laying solution is ideal for projects where permanent floor laying is not possible.



Çakıl üzerine
montaj
*Laying on
gravel*

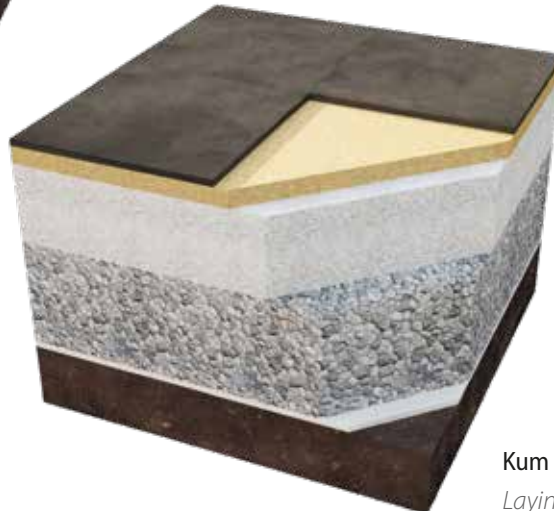

Kum üzerine montaj
Laying on sand



outdoor 20 mm & 30 mm

YAPIŞTIRICI İLE UYGULAMA

Adhesive installation

Açık yüzeyler, otoparklar, garaj rampaları için ideal döşeme çözümü, döşenen yüzey hem dinamik hem de yoğun yüklere karşı son derece dayanıklıdır. Genleşme derzleri gereklidir ve karolar arasındaki boşluklar çimento esaslı harç ile doldurulmalıdır.

The ideal laying solution for outdoor driveways, car parks, garage ramps, as the laid surface is extremely resistant to both dynamic and concentrated loads. Expansion joints are required, and the gaps between the tiles must be filled with cement-based grout.



Yapışkan üzerine montaj
Adhesive installation

outdoor 20 mm & 30 mm



YÜKSELTİLMİŞ AYAK SİSTEMİ ÜZERİNE KURULUM

*Installation on
raised pedestal
system*

Bu döşeme sistemi ile, karonun altına döşenen tüm boru ve kablo sistemleri her zaman kontrol edilebilir. Karoların kaldırılması ve çıkarılmasıyla anında erişilebilirlik sunar.

With this laying system, all the pipes and wiring systems laid beneath the tiled surface can be inspected at any time. It offers instant accessibility, simply by lifting and removing the slabs.



Sabit destek
Fixed support



Ayarlanabilir destek
Adjustable support

Yükseltilmiş Döşeme Sistemi

*Raised floor
system*

Yükseltilmiş zemin ve taban yüzeyi arasında boş bir kullanım alanı elde edilir. Konut ve işyerleri gibi iç mekan uygulamalarda bu alan, aydınlatma sistemleri, kablo ve boruların hem kolaylıkla döşenmesini hem de kontrol edilebilmesini sağlar. Ayrıca dış mekan uygulamalarında, seramikler arasında 2 mm den 4 mm ye kadar derz boşluğu oluşturur. Bu sayede, yağmur sularının hızlı bir şekilde tahliyesini kolaylaştırır. Ses ve ısı yalıtımını artırır, eğimli ve bozuk yüzeylerde kolaylıkla uygulanır.

Sistemin uygulanması için uzman bir döşeme ustası şart değildir, kurulumu kolay ve hızlı uygulanabilir. Ürünlerimiz %100 çevreye zararsız malzemeden yapılmaktadır. Olumsuz hava şartlarında -40° ile +80° arasında sıcaklıklara dayanıklıdır.

An accessible space is provided between the raised floor and base surface. In residential and commercial uses, this space can be utilized for easy layout and inspection of electrical wiring and mechanical piping. Also it provides a gap of 2 mm to 4 mm between the tiles for outdoor uses. This gap helps rapid drainage of rainwater, enhances sound and heat insulation values, and makes it easy to install on sloped and uneven surfaces.

There is no need for an experienced layout crew, can be easily and rapidly applied. Our products are manufactured with 100% ecologically harmless materials. Resistant to ambient temperatures between -40°C and +80°C.

outdoor 20 mm & 30 mm

BS60

— BASIC SERIES —

BS60 serisi yükseltilmiş zemin sistemi ayakları, 32 mm'den 250 mm'ye kadar olan, sabit ya da değişken ölçülerde zemin oluşturmak için uygulanabilir. Ürünlerimiz %100 çevreye duyarlı malzemeden yapılmaktadır. Olumsuz hava koşullarına karşı ve -40° ile +80° arasında sıcaklıklara dayanıklıdır.

BS60 serisi yükseltilmiş zemin sistemi uygulamasında, yükün eşit şekilde dağıtılmasını sağlamak için, karonun merkezinde beşinci bir ayak kullanılmasını önerilmektedir.

BS60 series raised floor system is suitable for clearances between 32mm and 250mm. System components are made by 100% environmentally friendly materials and resistant to ambient temperatures between -40°C and +80°C.

In BS60 series raised floor applications, we advise usage of fifth leg in the center of the tile for more even load distribution.



BS60-01 (32-38mm) BS60-02 (38-50mm) BS60-03 (50-75mm) BS60-04 (73-110mm) BS60-05 (102-130mm) BS60-06 (126-155mm) BS60-07 (147-184mm) BS60-08 (175-205mm) BS60-09 (200-225mm) BS60-10 (220-250mm)



outdoor 20 mm & 30 mm

SL60

— MAXI SERIES —



Otomatik yüzey düzleştirme sistemi ile birlikte karolaj döşemesinde kullanılan modül. Maksimum %5 eğime kadar olan yüzeylerde kullanıldığında eğimin otomatik olarak düzleştirilmesini sağlar.

Self leveling header for laying out the tiles. Allows self leveling while using on uneven surfaces having up to 5% slope.



SL60-01
(42-48mm)

SL60-02
(48-60mm)

SL60-03
(60-85mm)

SL60-04
(83-120mm)

SL60-05
(112-140mm)

SL60-06
(136-165mm)

SL60-07
(157-194mm)

SL60-08
(185-215mm)

SL60-09
(210-235mm)

SL60-10
(230-260mm)

Avantajları Nelerdir?

*What are the
advantages ?*

Boru ve kabloların görünmesini engeller
Yapısal hareketleri emer deformasyonu engeller
Yapılarda daha az ağırlık
Terazileme işlemi çok daha kolay
Hızlı uygulama ve zaman tasarrufu
Hızlı su drenajı
Daha iyi ısı akışı
Kırılmaya karşı yüksek mukavemet
Ses izolasyonu
Çevreye duyarlı

*Hides wiring and pipes
Absorbs structural movements and blocks deformations
Decreases dead weight on structures
Easier leveling
Rapid application saves time.
Rapid water drainage.
Better heat insulation
High resistance to breaking
Sound insulation
Environmentally safe.*



max. 54 cm



outdoor 20 mm & 30 mm

BS110

— MAXI SERIES —

BS110 serisi yükseltilmiş zemin sistemi ayakları, 75 mm'den 540 mm ve üzeri, sabit ya da değişken yüksekliklerde zemin oluşturmak için kullanılır. SLC001 otomatik düzeltme kafası ile birlikte kullanıldığında maksimum %5 eğime kadar olan yüzeylerin düzleştirilmesini sağlar. Ürünlerimiz %100 geri dönüşümlü malzemeden yapılmaktadır. Çevreye zararı yoktur. Olumsuz hava koşullarına karşı ve -40° ile $+80^{\circ}$ arasında sıcaklıklara dayanıklıdır. Manşonların tam sıkılı halde kullanılması tavsiye edilir.

BS110 series raised floor system is suitable for clearances between 75mm and 540mm. When used in conjunction with SLC001 self leveling header, provides while using on uneven surfaces having up to 5% slope

System components are made by 100% environmentally friendly materials and resistant to ambient temperatures between -40°C and $+80^{\circ}\text{C}$. It is advised that all threads are snug tight.

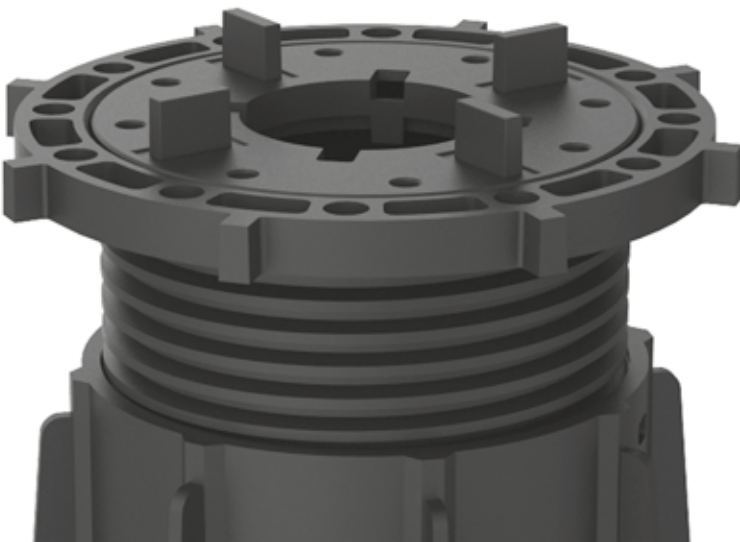

SL110

— MAXI SERIES —



Otomatik yüzey düzleştirme sistemi ile birlikte karolaj döşemesinde kullanılan modül. Maksimum %5 eğime kadar olan yüzeylerde kullanıldığında eğimin otomatik olarak düzleştirilmesini sağlar.

Module that is used for tile layout with self leveling system. When used in areas up to 5% slopes, it provides a level surface.



SL110-04
(85-135mm)

SL110-05
(130-180mm)

SL110-06
(180-228mm)

SL110-07
(224-272mm)

SL110-08
(273-322mm)

SL110-09
(317-366mm)

SL110-10
(367-415mm)

SL110-11
(410-460mm)

SL110-12
(460-510mm)

SL110-13
(505-553mm)

Zemin Artısı Floor Cross



Zemin artısı, kum, çakıl, taş tozu veya çim yüzeyli parklarda, bahçelerde ve meydanlarda hızlı bir şekilde zemin uygulaması sağlar.

Özel seramiklerin ve doğal taşların mekanlara hızlı ve etkili bir şekilde uygulanmasını kolaylaştırır. 3 mm'lik malzeme aralığı oluşturarak hassas bir derz kanalı ve mükemmel bir stabilite oluşturur.

3 mm'lik derz aralığı sayesinde zemin üzerinde biriken suların hızlı drenajına imkan tanır. Üzerinde bulunan kesme hatları kullanılarak, kolayca kesilir ve 4 farklı açıda kullanılabilir.

Floor cross element enables tile laying in parks, gardens and squares over sand, gravel and crushed stone. Leaving 3mm gap between the tiles, it provides a precise joint spacing, excellent stability and fast drainage of surface water.

Can be easily cut through the trim lines and could be used in four different angles.

Drenaj Kanalı Drainage Gap

Drainage Gap

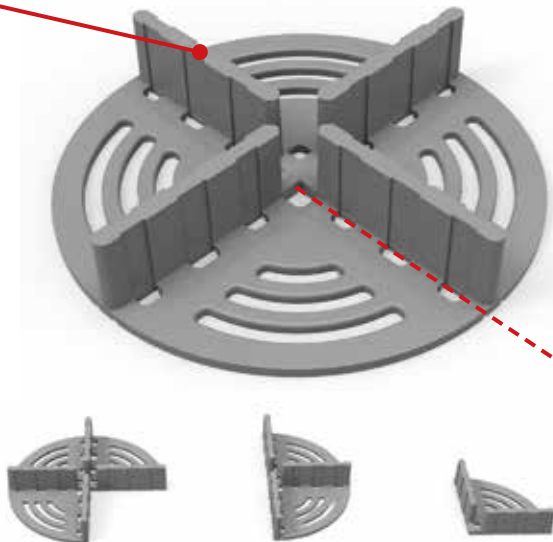

Kesim çizgisi / Trim Line

Zemin Artısı işaretli yerden kesilerek döşemenin gereksinimine göre yandaki modüllere dönüştürülebilir.

Floor cross element can be cut along the perforation in order to suit the floor requirements as shown.

maximum eğim
%0.5



SLC001

— PEDESTAL SISTEM —

Otomatik yüzey düzleştirme sistemi Basic ve Maxi serileri ile uyumlu ve modülerdir.

Maksimum %5 eğimli yüzeylerde modüllerin üzerine takılarak kullanılır. Böylece eğimi ortadan kaldırarak, yükseltilmiş döşeme yüzeyini düzleştirir. Otomatik yüzey düzleştirme sistemi, 360° dönebildiğinden, eğim yönünün tespit edilmesine yardımcı olur.

Self leveling system is modular and compatible with Basic and Maxi series.

Used on uneven surfaces of max 5% slope. It eliminates the slope and makes the tile surface horizontal. Since it can freely rotate 360°, it will help determine the direction of slope.

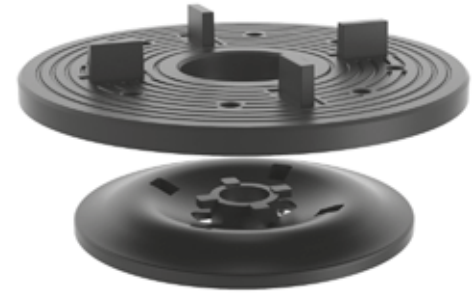

SL60



SL110



Değiştirilebilir Derz Pimleri

Replacable Spacers

Basic, Maxi ve SP serileri ile kullanılabilen tüm modüllerde aynı tip derz pimi kullanılır. Bu pimler isteğe bağlı olarak değiştirilebilir.

2 mm, 3 mm ve 4 mm kalınlığında olan pimler yuvalarından kolaylıkla çıkarılıp tekrar takılabilir. Bu sayede, disk üzerinde herhangi bir kırma işlemi yapılmadığından, modüller farklı yerlerde ve farklı derz pimleri ile kullanılabilir.

Dış mekan uygulamalarında yağmur ve kar sularının deşarjını kolaylaştırmak için 4 mm pim kullanılması tavsiye edilir.

Same type of spacers are used in all modules of Basic, Maxi and SP series. These spacers are replaced as required.

2mm, 3mm and 4mm wide spacers can easily be removed and re installed. This way, without any damage on the header disk, the standard modules can be used in various locations with different spacers.

For outdoor applications, it is advised to use 4mm spacers for better drainage of snow and rain water.

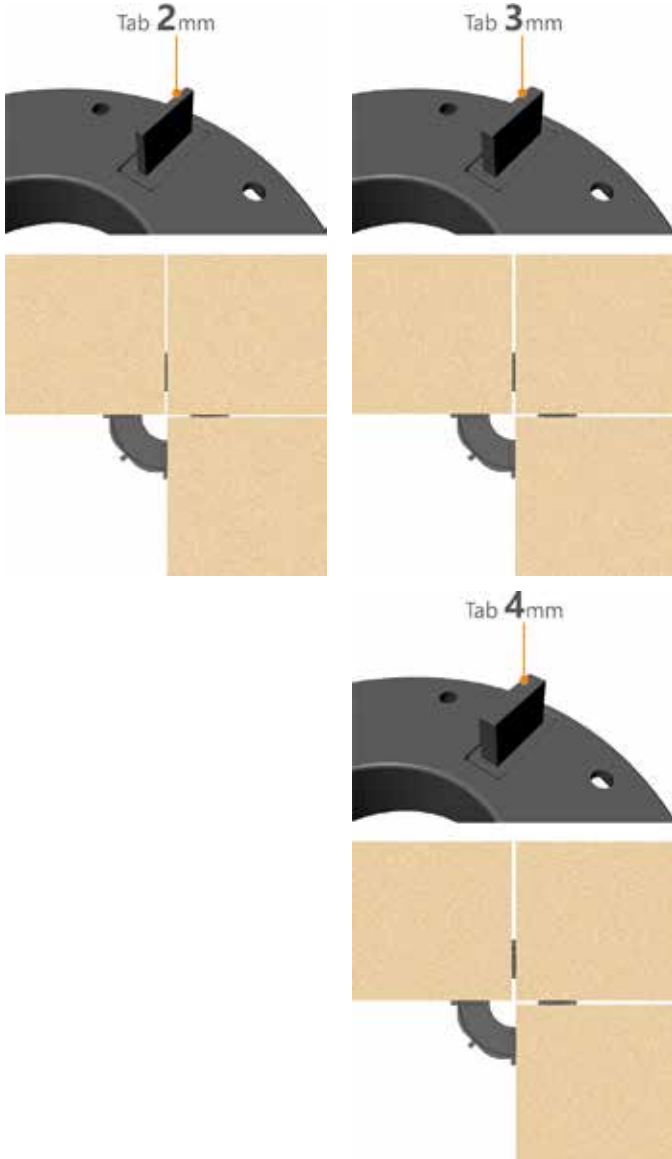

Yanal Yüzey Kaplama

Side Panel

Yanal yüzey kapama aksesuarları, uygulama yapılan yükseltilmiş döşemenin açıkta kalan yan kenarlarının, uygulama yapılan döşeme malzemeleri ile kolay ve hızlı bir şekilde kapatılabilmesine olanak sağlar.

Side panel accessories enable closing the open sides of raised floor applications by using the same material as the floor tiles.



Ayar Anahtarı

Adjustment Wrench



Bu ürün, yükseltilmiş döşeme ayakları için tasarlanmış, kolay ayarlama anahtarıdır. Uygulama sırasında ilk ayarlama el ile kolaylıkla yapılabilmektedir, fakat yükseltilmiş döşeme ayaklarının üzerine karolar ya da döşeme elemanları yerleştirilmeye başlandıkça baskı artar ve el ile ayarlama zorlaşır.

Bu aşamada ayarlama anahtarı karoların tesviye edilmesini kolaylaştırır.

Enables easy height adjustment of raised floor pedestals. During the installation, initial adjustments are done by hand. But as the tiles are placed over the pedestals, it becomes harder to adjust manually.

In this stage, the adjustment wrench helps leveling the tiles.



SP10 - Yükseltilmiş Döşeme Ayağı

SP10 - Raised floor pedestal



10 mm'den 30 mm'ye ayaryükseltilebilme özelliği

Ability to adjust for 10 mm to 30 mm height.

SP10 Modül ile 10 mm'den başlayarak 30 mm ye yükseltilebilen, yükseltilmiş zeminler oluşturmak mümkündür. Sistem kolay ayarlanabilme imkanına sahiptir. SP10 Modül, kendi içinde 10 mm'den 15 mm'ye kadar yükselir. İhtiyaç duyulması halinde, SP-5 plaka SP10 Modülün altına eklenerek 5 mm daha fark elde edilir. SP5 plaka, birbiri üstüne takılarak birden fazla kullanılabilir. SP10 Modül ve SP5 plaka kullanılarak, 10 mm den 30 mm ye kadar yükseltilmiş zemin uygulaması yapılabilir.

30 mm den yüksek döşemeler için BS60 serisi kullanılır. Özel Tasarımı ve üretim değerlerine bağlı olarak yüksek kırılma dayanımına sahiptir.

With SP10 modules, it is possible to lay out raised floors of 10mm to 30mm. System is easily adjusted. Each SP10 module can be set to a height of 10mm to 15mm. When required, SP-5 plates can be added to raise it 5mm more. More than one SP-5 plates can be fixed on top of each other to reach the necessary height. Using SP10 modules and SP-5 plates, final height of 10mm to 30mm can be achieved. For floor heights exceeding 30mm, BS60 series is used. It has high resistance to breaking by its special design and production characteristics.

SP10 Modül



SP5 Plaka



outdoor 20 mm & 30 mm

PAKETLEME VE YÜKLEME DETAYI

Packaging & loading Details

60x120x2 cm

24"x48"

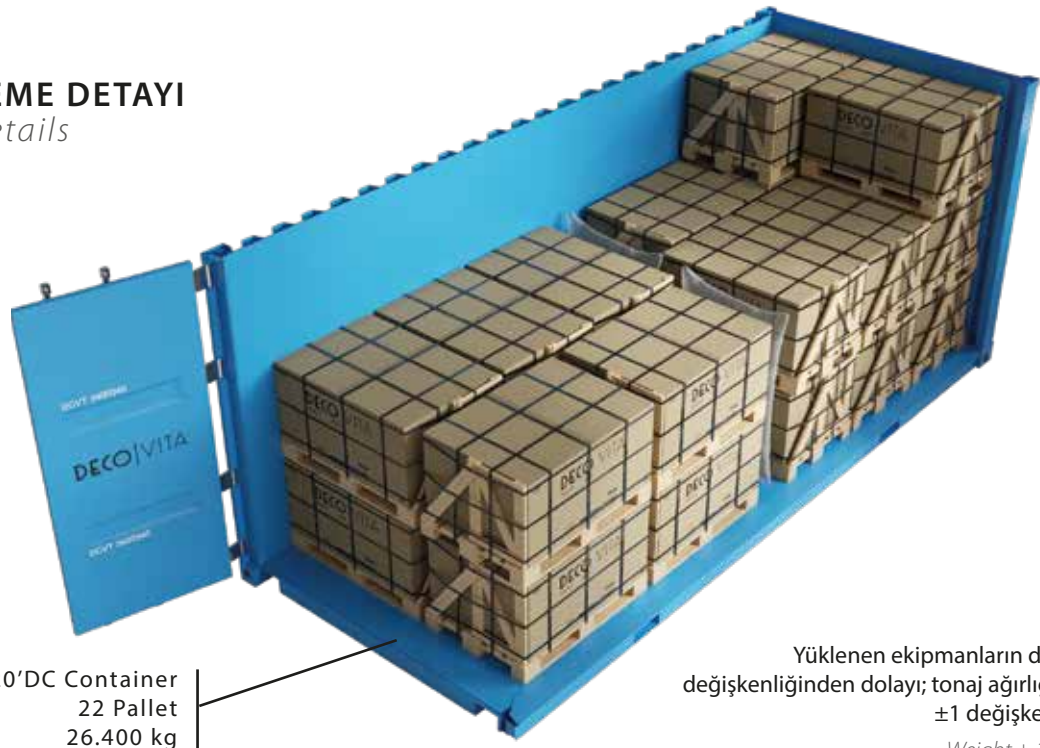

20' DC Container
22 Pallet
26.400 kg

Yüklenen ekipmanların dара ağırlıklarının değişkenliğinden dolayı; tonaj ağırlığındaki değerler ± 1 değişkenlik gösterebilir.

Weight ± 1 may be different.

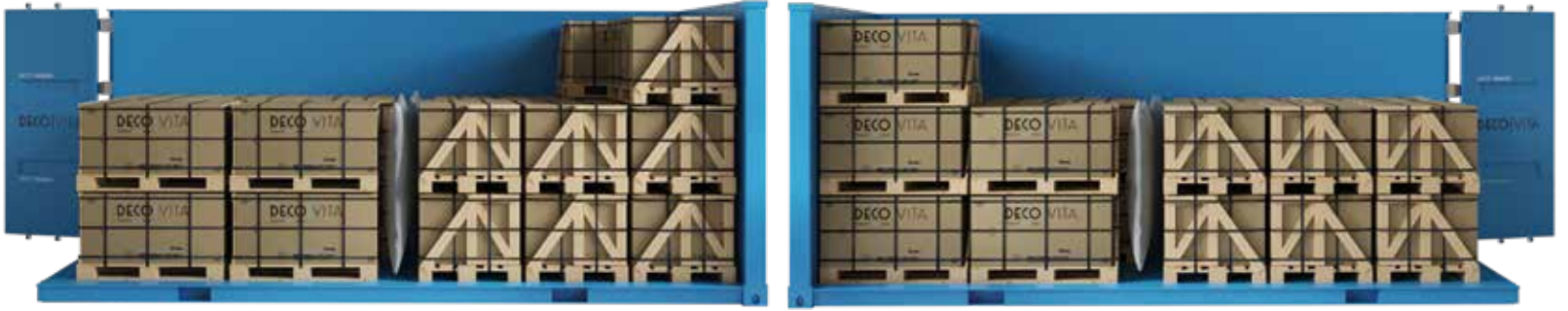

KONTEYNER BİLGİLERİ

Container Informations

20' DC Konteyner / Container

TONAJ Tonnage	Palet Pallet	Ağırlık Weight	Miktar Quantity
21 - 22 TON	18 plt	21.600 kg	414,72 m ²
22 - 23 TON	19 plt	22.800 kg	437,76 m ²
23 - 24 TON	20 plt	24.000 kg	460,80 m ²
24 - 25 TON	20 plt	24.000 kg	460,80 m ²
25 - 26 TON	21 plt	25.200 kg	483,84 m ²
26 - 27 TON	22 plt	26.400 kg	506,88 m ²

PALET BİLGİLERİ

Pallet Informations

Kutu (kutu/palet) Boxes (box/pallet)	32 kutu / box
Miktar (m2/palet) Quantity (m2/pallet)	23,04 m ² / 248 ft ²
Ağırlık (kg/palet) Weight (kg/pallet)	1.200 kg
Palet Ebatı Pallet Size	93x128x75 cm 37.2x51.2x30 inch

KUTU BİLGİLERİ

Box Informations

ÜRÜN KALINLIĞI Thickness of Tile	2 cm / 0.8 inch
Adet (ad/kutu) Pieces (pcs/box)	1 adet / 1 pieces
Miktar (m2/kutu) Quantity (s m/box)	0,72 m ² / 7.75 ft ²
Ağırlık (kg/kutu) Weight (kg/box)	37 kg



PAKETLEME VE YÜKLEME DETAYI

Packaging & loading Details

60x60x2 cm

24"x24"

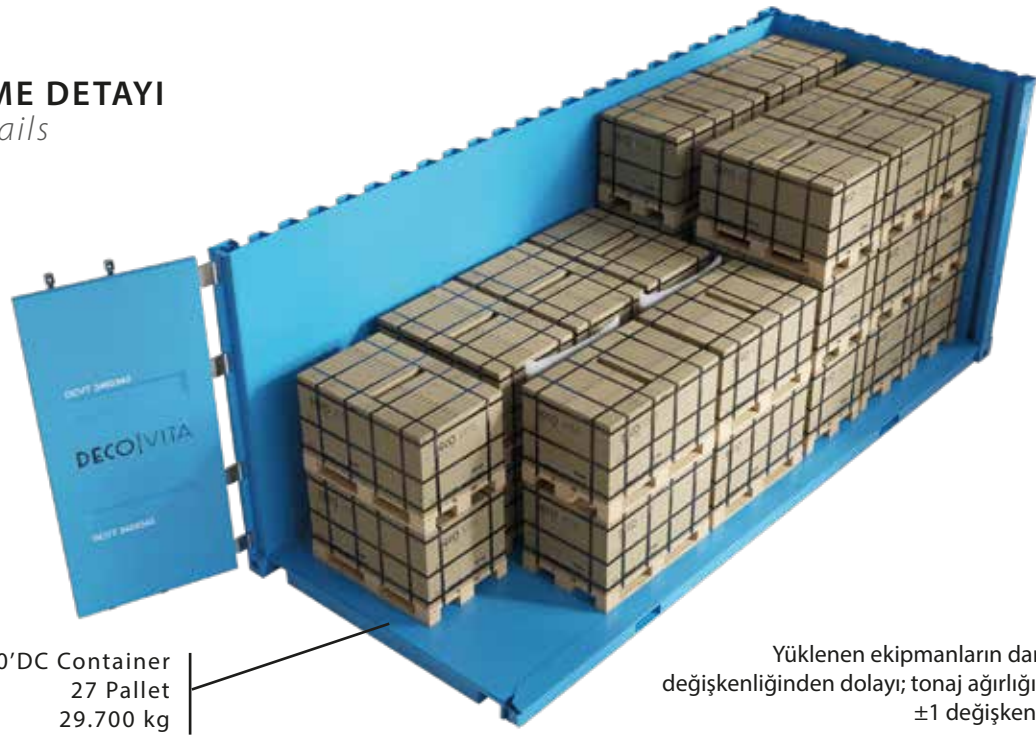

20' DC Container
27 Pallet
29.700 kg

Yüklenen ekipmanların dala ağırlıklarının deęişkenliğinden dolayı; tonaj ağırlığındaki deęerler ± 1 deęişkenlik gösterebilir.
Weight ± 1 may be different.

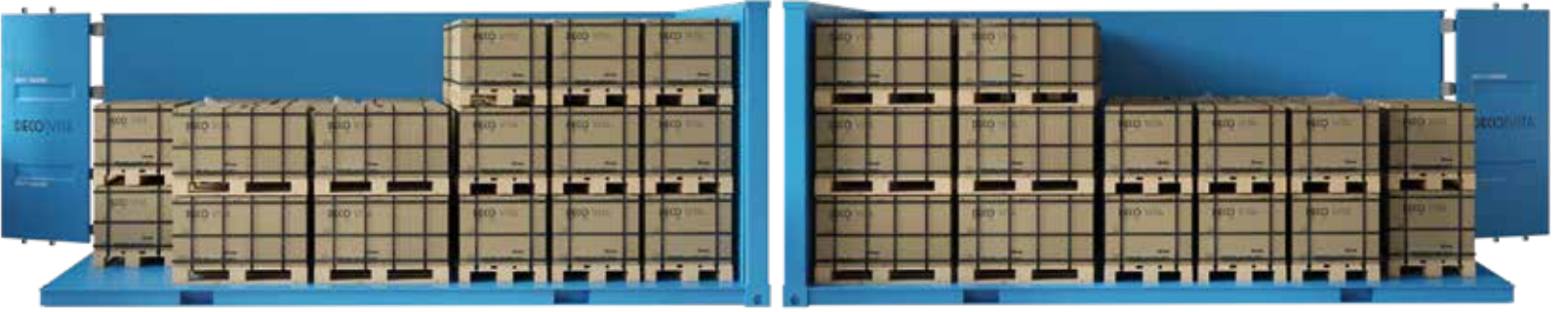

KONTEYNER BİLGİLERİ

Container Informations

20' DC Konteyner / Container				
TONAJ Tonnage	Palet Pallet	Ağırlık Weight	Miktar Quantity	
21 - 22 TON	22 plt	24.200 kg	475,20 m ²	
22 - 23 TON	23 plt	25.300 kg	496,80 m ²	
23 - 24 TON	24 plt	26.400 kg	518,40 m ²	
24 - 25 TON	25 plt	27.500 kg	540,00 m ²	
25 - 26 TON	26 plt	28.600 kg	561,60 m ²	
26 - 27 TON	27 plt	29.700 kg	583,20 m ²	

PALET BİLGİLERİ

Pallet Informations

Kutu (kutu/palet) Boxes (box/pallet)	30 kutu / box
Miktar (m2/palet) Quantity (m2/pallet)	21,60 m ² / 232.5 ft ²
Ağırlık (kg/palet) Weight (kg/pallet)	1.100 kg
Palet Ebatı Pallet Size	80x120x75 cm 32x48x30 inch

KUTU BİLGİLERİ

Box Informations

ÜRÜN KALINLIĞI Thickness of Tile	2 cm / 0.8 inch
Adet (ad/kutu) Pieces (pcs/box)	2 adet / 2 pieces
Miktar (m2/kutu) Quantity (s m/box)	0,72 m ² / 7.75 ft ²
Ağırlık (kg/kutu) Weight (kg/box)	36 kg



outdoor 20 mm & 30 mm

PAKETLEME VE YÜKLEME DETAYI

Packaging & loading Details

60x60x3 cm

24"x24"



20'DC Container
27 Pallet
20.000 kg

Yüklenen ekipmanların dара ağırlıklarının
değişkenliğinden dolayı; tonaj ağırlığındaki değerler
±1 değişkenlik gösterebilir.
Weight ± 1 may be different.



KONTEYNER BİLGİLERİ

Container Informations

20'DC Konteyner / Container

TONAJ Tonnage	Palet Pallet	Ağırlık Weight	Miktar Quantity
21 - 22 TON	22 plt	22.000 kg	316,80 m ²
22 - 23 TON	23 plt	23.000 kg	331,20 m ²
23 - 24 TON	24 plt	24.000 kg	345,60 m ²
24 - 25 TON	25 plt	25.000 kg	360,00 m ²
25 - 26 TON	26 plt	26.000 kg	374,40 m ²
26 - 27 TON	27 plt	27.000 kg	388,80 m ²

PALET BİLGİLERİ

Pallet Informations

Kutu (kutu/palet) Boxes (box/pallet)	40 kutu / box
Miktar (m ² /palet) Quantity (m ² /pallet)	14,40 m ² / 155 ft ²
Ağırlık (kg/palet) Weight (kg/pallet)	1.000 kg
Palet Ebatı Pallet Size	80x120x75 cm 32x48x30 inch

KUTU BİLGİLERİ

Box Informations

ÜRÜN KALINLIĞI Thickness of Tile	3 cm / 1.2 inch
Adet (ad/kutu) Pieces (pcs/box)	1 adet / pieces
Miktar (m ² /kutu) Quantity (s m/box)	0,36 m ² / 3.87 ft ²
Ağırlık (kg/kutu) Weight (kg/box)	24.5 kg



Bu ürün kutusuz paletlenmektedir.
This size is palletized without carton box.

PAKETLEME VE YÜKLEME DETAYI

Packaging & loading Details

30x60x3 cm

12"x24"

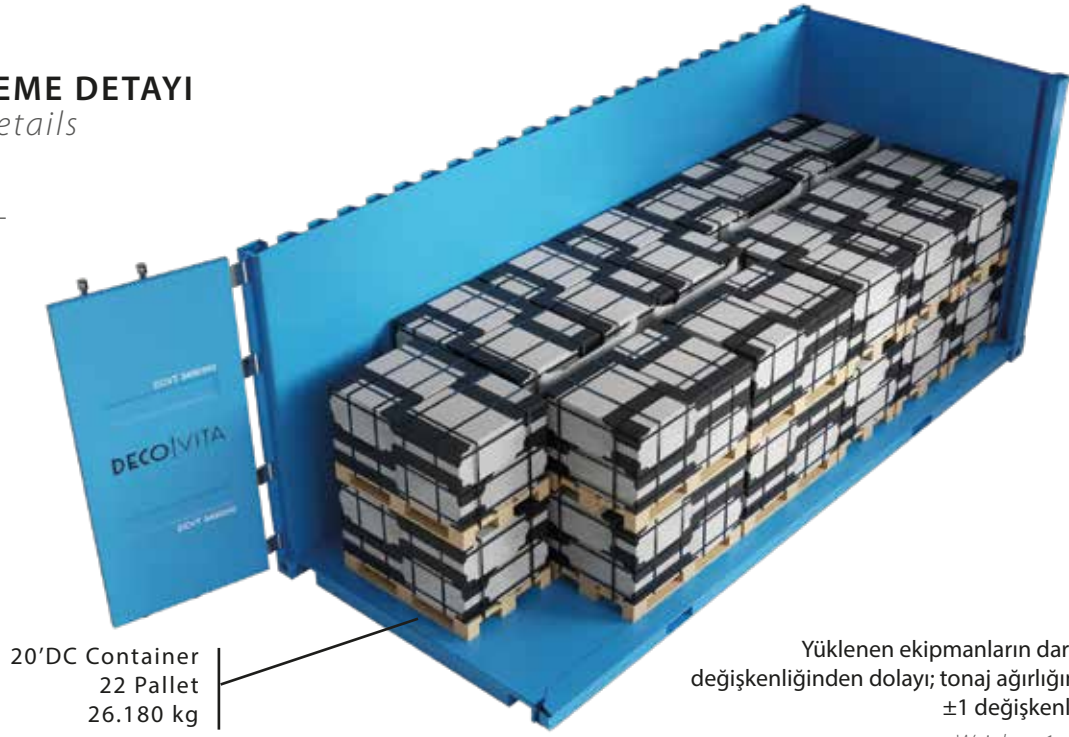

20'DC Container
22 Pallet
26.180 kg

Yüklenen ekipmanların dара ağırlıklarının değişkenliğinden dolayı; tonaj ağırlığındaki değerler ± 1 değişkenlik gösterebilir.
Weight ± 1 may be different.

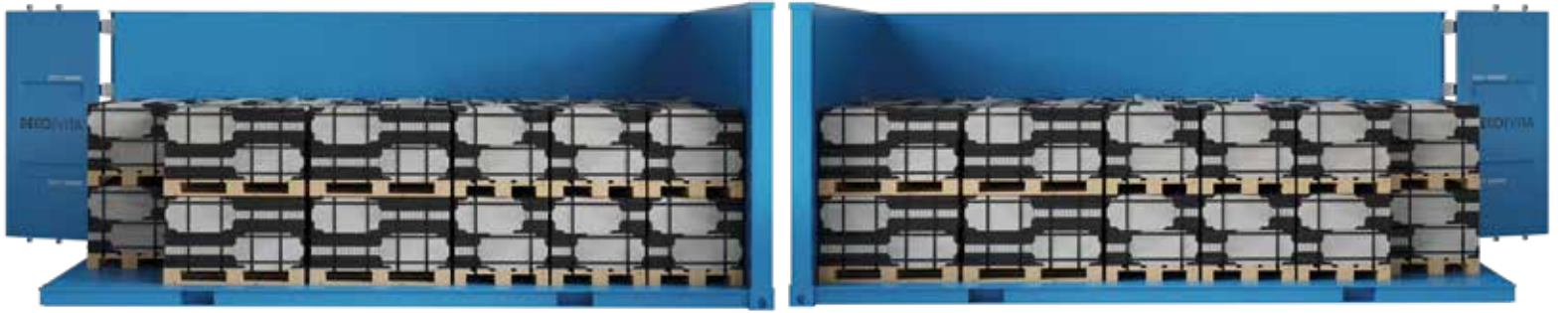

KONTEYNER BİLGİLERİ

Container Informations

20'DC Konteyner / Container				
TONAJ Tonnage	Palet Pallet	Ağırlık Weight	Miktar Quantity	
21 - 22 TON	18 plt	21.420 kg	311,04 m ²	
22 - 23 TON	19 plt	22.610 kg	328,32 m ²	
23 - 24 TON	20 plt	23.800 kg	345,60 m ²	
24 - 25 TON	21 plt	24.990 kg	362,88 m ²	
25 - 26 TON	21 plt	24.990 kg	362,88 m ²	
26 - 27 TON	22 plt	26.180 kg	380,16 m ²	

PALET BİLGİLERİ

Pallet Informations

Kutu (kutu/palet) Boxes (box/pallet)	48 kutu / box
Miktar (m2/palet) Quantity (m2/pallet)	17,28 m ² / 186 ft ²
Ağırlık (kg/palet) Weight (kg/pallet)	1.190 kg
Palet Ebatı Pallet Size	80x120x75 cm 32x48x30 inch

KUTU BİLGİLERİ

Box Informations

ÜRÜN KALINLIĞI Thickness of Tile	3 cm / 1.2 inch
Adet (ad/kutu) Pieces (pcs/box)	2 adet / pieces
Miktar (m2/kutu) Quantity (s m/box)	0,36 m ² / 3.87 ft ²
Ağırlık (kg/kutu) Weight (kg/box)	24.4 kg



Bu ürün kutusuz paletlenmektedir.
This size is palletized without carton box.

outdoor 20 mm & 30 mm

PAKETLEME VE YÜKLEME DETAYI

Packaging & loading Details

90x90x3 cm

36"x36"

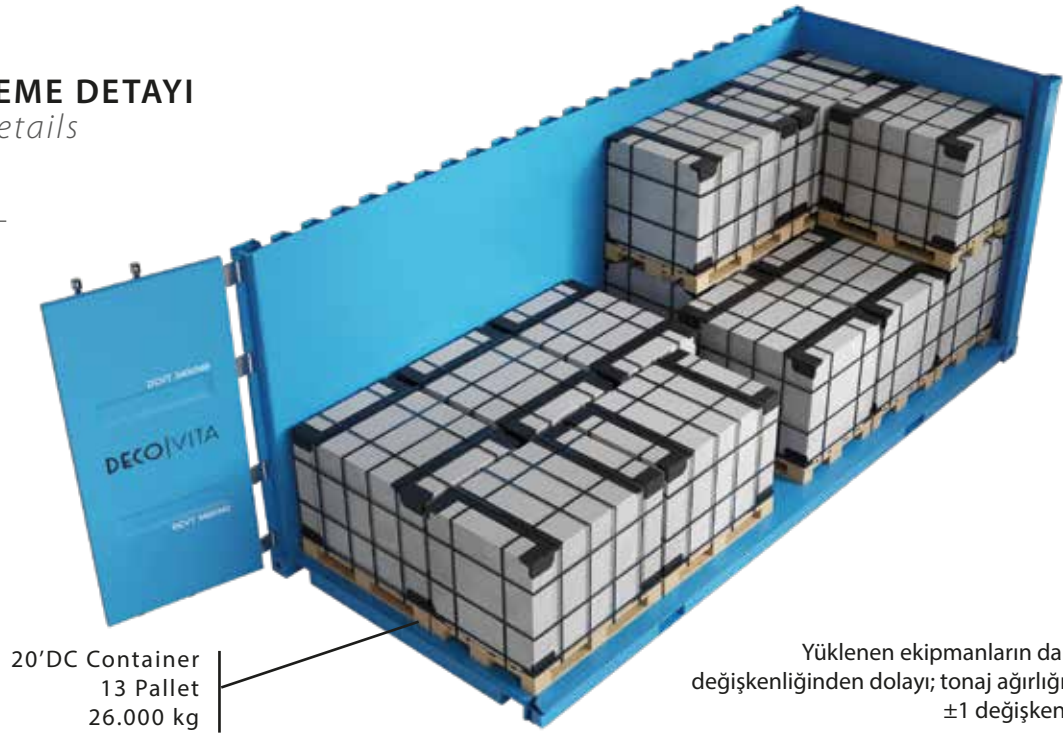

20' DC Container
13 Pallet
26.000 kg

Yüklenen ekipmanların tara ağırlıklarının değişkenliğinden dolayı; tonaj ağırlığındaki değerler ± 1 değişkenlik gösterebilir.
Weight ± 1 may be different.



KONTEYNER BİLGİLERİ

Container Informations

20' DC Konteyner / Container				
TONAJ Tonnage	Palet Pallet	Ağırlık Weight	Miktar Quantity	
21 - 22 TON	11 plt	22.000 kg	320,76 m ²	
22 - 23 TON	11 plt	22.000 kg	320,76 m ²	
23 - 24 TON	12 plt	24.000 kg	349,92 m ²	
24 - 25 TON	12 plt	24.000 kg	349,92 m ²	
25 - 26 TON	13 plt	26.000 kg	379,08 m ²	
26 - 27 TON	13 plt	26.000 kg	379,08 m ²	

PALET BİLGİLERİ

Pallet Informations

Kutu (kutu/palet) Boxes (box/pallet)	36 kutu / box
Miktar (m2/palet) Quantity (m2/pallet)	29,16 m ² / 313.87 ft ²
Ağırlık (kg/palet) Weight (kg/pallet)	2.000 kg
Palet Ebatı Pallet Size	93x128x105 cm 37.2x51.2x42 inch

KUTU BİLGİLERİ

Box Informations

ÜRÜN KALINLIĞI Thickness of Tile	3 cm / 1.2 inch
Adet (ad/kutu) Pieces (pcs/box)	1 adet / pieces
Miktar (m2/kutu) Quantity (s m/box)	0,81 m ² / 8.72 ft ²
Ağırlık (kg/kutu) Weight (kg/box)	55 kg



Bu ürün kutusuz paletlenmektedir.
This size is palletized without carton box.

PAKETLEME VE YÜKLEME DETAYI

Packaging & loading Details

80x80x2 cm

32"x32"

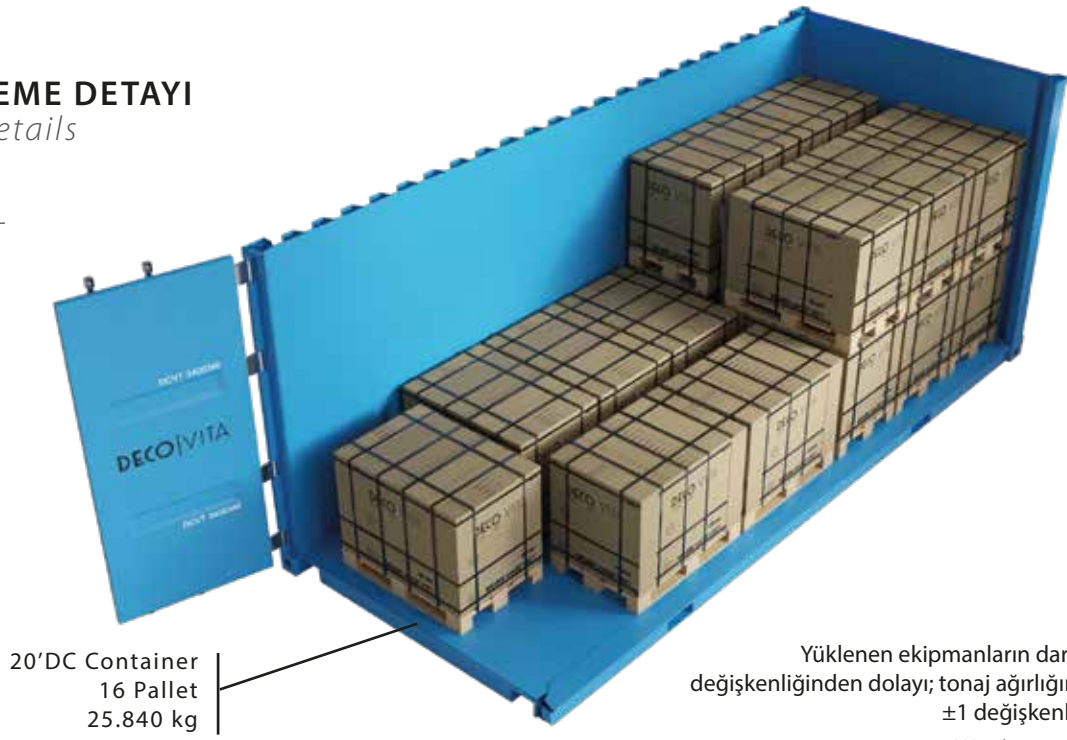

20' DC Container
16 Pallet
25.840 kg

Yüklenen ekipmanların tara ağırlıklarının değişkenliğinden dolayı; tonaj ağırlığındaki değerler ± 1 değişkenlik gösterebilir.
Weight ± 1 may be different.



KONTEYNER BİLGİLERİ

Container Informations

20' DC Konteyner / Container

TONAJ Tonnage	Palet Pallet	Ağırlık Weight	Miktar Quantity
21 - 22 TON	13 plt	20.995 kg	416,00 m ²
22 - 23 TON	14 plt	22.610 kg	448,00 m ²
23 - 24 TON	14 plt	22.610 kg	448,00 m ²
24 - 25 TON	15 plt	24.225 kg	480,00 m ²
25 - 26 TON	16 plt	25.840 kg	512,00 m ²
26 - 27 TON	16 plt	25.840 kg	512,00 m ²

PALET BİLGİLERİ

Pallet Informations

Kutu (kutu/palet) Boxes (box/pallet)	50 kutu / box
Miktar (m2/palet) Quantity (m2/pallet)	32 m ² / 344.44 ft ²
Ağırlık (kg/palet) Weight (kg/pallet)	1.615 kg
Palet Ebatı Pallet Size	80x120x95 cm 32x48x38 inch

KUTU BİLGİLERİ

Box Informations

ÜRÜN KALINLIĞI Thickness of Tile	2 cm / 0.8 inch
Adet (ad/kutu) Pieces (pcs/box)	1 adet / pieces
Miktar (m2/kutu) Quantity (s m/box)	0,64 m ² / 6.89 ft ²
Ağırlık (kg/kutu) Weight (kg/box)	32 kg



outdoor 20 mm & 30 mm

TANIMLAMA SPECIFICATION	TEST METODU TEST METHOD	REFERANS DEĞERİ REFERENCE VALUE	KESİN DEĞERİ DECLARED VALUE
Static coefficient of friction	ASTM - C 1028	> 0,60 dry and wet	> 0,70 dry and wet
Dynamic coefficient of friction (section 9.6 ANSIA 137.1 2012)	DCOF Acutest	> 0.42 wet	> 0.60 wet
Resistance to freeze	ASTM - C 1026	required	Resistant
Frost resistance	ISO - 10545-12	As reported	Resistant
Chemical resistance	ASTM - C 650	As reported	Not affected
Resistance to domestic chemicals and additives for swimming pools	ISO - 10545-13	UB minimum	UA
Resistance to low concentrations of acids and alkali	ISO - 10545-14	See manufacturer's declaration	ULA
Resistance to high concentrations of acids and alkali	ISO - 10545-15	See manufacturer's declaration	UHA
Resistance to staining	ASTM - C 1378	As reported	Not affected
	ISO - 10545-14	-	4
Maximum straightness deviation, in %, in relation to the corresponding production dimensions	ASTM - C 485	±0.75% (±1.8 mm)	±10%
	ISO - 10545-2	±0,5% (±1,5 mm)	±10%
Admitted deviation, in %, of the average thickness of each tile from the production dimensions	ASTM - C 499	± 1.2 mm	±0.5%
	ISO - 10545-2	±0,5% (±0,5 mm)	±0.5%
Length and width: admitted deviation, in %, of the average size of each tile from the production dimensions	ASTM - C 499	±0.5 % (±2.0 mm)	± 0.15 %
	ISO - 10545-2	±0,6 % (±2 mm)	± 0.15 %
Amount of water absorbed, in percentage	ASTM - C 373	≤ 0.5%	≤ 0.5%
	ISO - 10545-3	≤ 0.5%	≤ 0.5%
Breaking strength in N (thickness > = 7,5 mm)	ASTM - C 648	≥ 2500 LBF Average	≥ 3000 LBF Individual
	ISO - 10545-4	≥ 1300 Newton	(20 mm) > 13000 (30 mm) > 30000
Resistance to deep abrasion of unglazed tiles	ASTM - C 1243	< 175 mm ³	< 150
	ISO - 10545-6	< 175 mm ³	< 150
Thermal shock resistance	ASTM - C 484	-	Meets the requirement
	ISO - 10545-9	-	Resistant

TEKNİK FAYDALAR / Technical Advantages

outdoor 20 mm & 30 mm

KALINLIK
Thickness

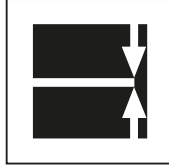

Kalınlığı nedeniyle, uygun bir şekilde monte edildiğinde, 2 cm'lik karo, yaklaşık 1000 kg/cm²'lik bir yük taşıma kapasitesi sağlar. 3 cm'lik karo, yaklaşık 3000 kg/cm²'lik bir yük taşıma kapasitesi sağlar. *Because of its thickness, when suitably installed, the 2 cm tile provides an approximate load bearing capacity of 1000 kg/cm², the 3 cm tile provides an approximate load bearing capacity of 3000 kg/cm².*

YÜKSELTİLMİŞ ZEMİN
Raised Floor

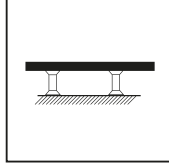

Diğer seramik ve porselen karolarla kıyaslandığında, 2 cm'lik ve 3 cm'lik karo, altında bulunan elektrik kabloları ve borularının muhafazası için yükseltilmiş destekler üzerine takviyeli olarak monte edilebilir. *Compared to other types of ceramic and porcelain tiles, the 2 cm and 3 cm tile can be installed unglued on raised supports to allow for housing electrical cables and pipes underneath.*

DUVAR SERAMİĞİ
Wall Tile

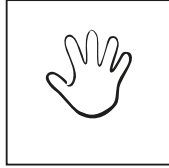

Duvar uygulamaları için 2 cm ve 3 cm karo mekanik olarak monte edilebilir. 2 cm'lik karo, binaların cepheleri için ideal olup, olağanüstü teknik özellikleri sayesinde hava koşullarına ve çizilmeye karşı dayanıklıdır. *The 2 cm & 3 cm tile can be mechanically installed for wall applications. The 2 cm tile is ideal for facades of buildings since its exceptional technical features provide superior resistance to weather conditions, scratching, etc.*

YAPIŞTIRICI YOK
No Adhesive



2 cm'lik ve 3 cm'lik karo, uygun maliyetli bir çözümdür çünkü kurulum, harç kullanılmasını gerektirmez. Çakıl ve toprak yüzeylerine uygulanabilir, ancak bir harç tabanına uygulandığında, yüzey kurulumdan önce düzleştirilmelidir. *The 2 cm & 3 cm tile is a cost-efficient solution since installation doesn't necessarily require using grout substrates. It can be applied on gravel and soil surfaces, but when applied on a mortar base, the surface should be leveled off prior to installation.*

YÜK TAŞIMA
Load carrying

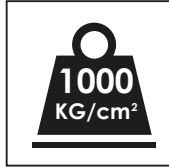

2 cm ve 3 cm kalınlığındaki karo, ağır yüklere karşı dayanıklılığa sahiptir. Ticari uygulamalar için en uygun döşeme olarak kabul edilir. Her levha 1000 kg ve 3000 kg'ın (2200 lb & 6600 lb) üzerindeki yüklere dayanabilir. *The 2 cm & 3 cm thick tile enjoys a high level of weightbearing capabilities and resistance to stress and heavy load objects. It is considered the best-fit tile for commercial applications. Because every slab can withstand loads of over 1000 kg (2200 lb & 6600 lb).*

DONA DAYANIKLI
Frost resistance

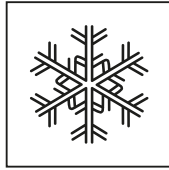

-50 °C ile +60 °C (-120 °F ila +140 °F) arasındaki sıcaklıklara dayanıklıdır. *Its properties remain unaltered at temperatures of -50°C to +60°C (-120°F to +140°F).*

TEMİZLEMESİ DAHA KOLAY
Easier to clean

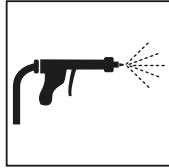

Özel bakım gerektirmez. Basıncı bir yıkayıcı ile kolayca temizlenebilir. *Because it requires no special or seasonal treatment and can be washed easily, even using a pressure washer.*

LEKELERE DAYANIKLI
Resistant to stains

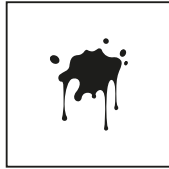

Zamanla değişmeden kaldığı için, küf ve yosun ve koyu lekeler tutmaz. *Because it remains unaltered over time, mould and moss and dark smudges cannot get a hold.*

KİMYASALLARA DAYANIKLI
Resistant to chemical aggression



Asitlere, kimyasal maddelere, tuzlara ve verimlere karşı dayanıklıdır. *Because it totally resists acids, chemical agents, salt and verdigris.*

KAYMAZ
Non slip



2 cm'lik ve 3 cm'lik karo, özellikle sık ıslanmaya maruz kalan alanlarda uygulandığında kaymaya karşı dayanıklı olduğundan yüksek güvenlik seviyesi garanti edilir. *High level of safety is guaranteed since the 2 cm & 3 cm tile is slip-resistant especially when applied in areas that are more subject to frequent wetting.*

ÇIKARILABİLİR
Removable

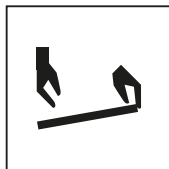

Çıkarılabilir ve tekrar kullanılabilir olduğundan, 60x60x2 cm plaka başına 17 kg. ağırlığında, 60x60x3 cm plaka başına 25 kg. ağırlığındadır. *Because it is removable, serviceable and reusable, weighing just 17 kg per 60x60x2 cm slabs and 25 kg per 60x60x3 cm.*

OUTDOOR MIN. R11 YÜZEY İÇİN KAYMA DİRENCİ TESTİ

Outdoor Tile Slip Resistance Measurement For Min. R11 Surfaces

Sarkaç Testi (Yüzeyin Kayma Direnci Tayini)

The pendulum testers - Method for measurement of slip resistant of a surface.

KURU METOT (DRY METHOD)

NUMUNE Sample	PTV 1.ÖLÇÜM Measure 1	PTV 2.ÖLÇÜM Measure 2	PTV 3. ÖLÇÜM Measure 3	PTV 4.ÖLÇÜM Measure 4	PTV 5.ÖLÇÜM Measure 5	PTV ORTALAMA Average
1	70	70	70	71	70	70

ISLAK METOT (WET METHOD)

NUMUNE Sample	PTV 1.ÖLÇÜM Measure 1	PTV 2.ÖLÇÜM Measure 2	PTV 3. ÖLÇÜM Measure 3	PTV 4.ÖLÇÜM Measure 4	PTV 5.ÖLÇÜM Measure 5	PTV ORTALAMA Average
1	65	65	65	66	64	65



RENK TONU DEĞİŞİMİ / Color shade variation

En az miktarda ton ve doku varyasyonu. Doğal olarak pişirilmiş kil ürünlerinde elde edilebilir.

The least amount of shade and texture variation. Attainable in naturally fired clay products.



Her kutuda hafif ve orta derecede gölge ve doku varyasyonu.

Light to moderate shade and texture variation within each carton.



Her kutuda yüksek doku tonu değişimi.

High shade texture variation within each carton.



Her kutuda çok fazla ton ve doku varyasyonu.

Very high shade and texture variation within each carton.



DECO | VITA

Decovita Yapı Ürünleri San. ve Tic. A.ş.

MERKEZ OFİS / Head Office:

Kayabaşı Mah. Ulubatlı Hasan Cad. D Blok No: 2H/D14-19 PK. 34494
Başakşehir / İstanbul / TÜRKİYE

T. +90 (850) 450 18 00 F. +90 (212) 906 06 95

FABRİKA / Factory:

Bozüyük Organize Sanayi Bölgesi 7. Cadde No: 4
Bozüyük / Bilecik / TÜRKİYE

T. +90 (850) 450 04 24

Follow us on: [f](#) [i](#) [t](#)

www.decovita.com.tr

